

## **OVERBERG DISTRICT MUNICIPALITY**

### **Q17-2020/21: SUPPLY AND DELIVERY OF GUARDRAIL BASEPLATES OR SUPPORTS**

Overberg District Municipality is currently awaiting quotations for the supply and delivery of guardrail baseplates or supports.

Enquiries regarding the technical specifications for this quotation may be directed to Mr. A Van Eeden at 028 050 0957 or email: [mvaneeden@odm.org.za](mailto:mvaneeden@odm.org.za)

Formal Quotation documents are available from Mr J Harmse at Tel: 028 050 910 or e-mail: [jharmse@odm.org.za](mailto:jharmse@odm.org.za) or Ms D Kapot-Witbooi at Tel: 028 050 0961 or e-mail: [dkapot@odm.org.za](mailto:dkapot@odm.org.za)

Sealed envelope endorsed "Q17-2020/21": SUPPLY AND DELIVERY OF GUARDRAIL BASEPLATES OR SUPPORTS must be placed in the tender box at the Municipal Offices, 26 Long Street, Bredasdorp, 7280 not later than 12:00 on Tuesday, 22 June 2021. Quotations will be opened in public thereafter.

Quotations submitted by fax, e-mail, or received after the closing time and date shall not be accepted. Quotations may only be submitted on the prescribed official document.

Overberg District Municipality shall apply its Municipal Supply Chain Management Policy as adopted in terms of section 111 of the Local Government Municipal Finance Management Act, 2003 (Act No 56 of 2003) and the relevant regulations. Quotations will be evaluated according to the criteria and weight of the 80/20 preferential procurement system. Bidders must submit a valid Tax Compliance status PIN, issued by the South African Revenue Services.

It is the prerogative of the municipality not to accept the lowest, a part of or any quotation at all.

**DP BERETTI**  
**MUNICIPAL MANAGER**



# OVERBERG DISTRICT MUNICIPALITY

**Closing Date:** 12:00 on Tuesday, 22 June 2021

**Bid No:** Q17-2020/21

**Bid Title:** SUPPLY AND DELIVERY OF GUARDRAIL  
BASEPLATES OR SUPPORTS

<b>COMPANY NAME</b>	<hr/> <hr/>
-------------------------	-------------

## INDEX

DESCRIPTION	PAGE NUMBERS
Invitation to Bid – MBD 1	4 - 5
Advert	6
General Bid Conditions and Information	7 - 13
Terms of Reference – TOR	14
Details of Bidder	15
Previous Experience	16
Authority of Signatory	17 – 18
Compulsory Enterprise Questionnaire	19
Documents of incorporation	20
Tax Compliance Status - MBD2 (Compulsory)	21
Pricing Schedule – MBD 3.1	22
Form of Offer and Acceptance	23 - 24
Declaration of Interest – MBD4 (Compulsory)	25 - 28
Responsiveness and Evaluation criteria	29 - 31
General Conditions of Contract – MBD5	32 - 43
Application of Preference Point System in terms of the Preferential Procurement Regulations 2017 – MBD6.1	44
Preference Points Claim form in terms of the Preferential Procurement Regulations 2017	45 - 51
Sworn Affidavit – B-BBEE EXEMPTED MICRO ENTERPRISE MBD6.1(a)	52
Contract Form – Purchases of goods / works – MBD7.1	53 - 54
Declaration of bidder’s past supply chain management practices – MBD8	55 - 56
Notification of decision	57
Certificate of Independent Bid Determination – MBD9	58 - 60
Key Performance Indicators MDB 16	61
Annexure A	62 - 63
Annexure B	64
Checklist for completeness of bid documentation	65

Initial

**IMORTANT**

- Do not dismember this Bid Document (do not take it apart).
- All other documents of your submission must be attached behind this Bid Document unless stated otherwise.
- The bidder must initial every page of the bid document.
- Where requested witnesses must sign the document. Failure to do this may invalidate your quotation.
- The checklist at the back of the bid document must be completed and adhered to.

**PART A  
INVITATION TO BID**

**YOU ARE HEREBY INVITED TO BID FOR REQUIREMENTS OF THE OVERBERG DISTRICT MUNICIPALITY**

BID NUMBER:	Q17-2020/21	CLOSING DATE:	22 June 2021	CLOSING TIME:	12h00
-------------	-------------	---------------	--------------	---------------	-------

DESCRIPTION	Supply and delivery of guardrail baseplates or supports
-------------	---

**THE SUCCESSFUL BIDDER WILL BE REQUIRED TO FILL IN AND SIGN A WRITTEN CONTRACT FORM (MBD7).**

BID RESPONSE DOCUMENTS MAY BE DEPOSITED IN THE BID BOX SITUATED AT (STREET ADDRESS)

**OVERBERG DISTRICT MUNICIPALITY**

**26 Long Street**

**Bredasdorp**

**7280**

**SUPPLIER INFORMATION**

NAME OF BIDDER					
POSTAL ADDRESS					
STREET ADDRESS					
TELEPHONE NUMBER	CODE		NUMBER		
CELLPHONE NUMBER					
FACSIMILE NUMBER	CODE		NUMBER		
E-MAIL ADDRESS					
VAT REGISTRATION NUMBER					
TAX COMPLIANCE STATUS	TCS PIN:			CSD No:	
B-BBEE STATUS LEVEL VERIFICATION CERTIFICATE [TICK APPLICABLE BOX]	<input type="checkbox"/> Yes  <input type="checkbox"/> No		B-BBEE STATUS LEVEL SWORN AFFIDAVIT <input type="checkbox"/> Yes  <input type="checkbox"/> No		

**[A B-BBEE STATUS LEVEL VERIFICATION CERTIFICATE/ SWORN AFFIDAVIT (FOR EMES & QSEs) MUST BE SUBMITTED IN ORDER TO QUALIFY FOR PREFERENCE POINTS FOR B-BBEE]**

ARE YOU THE ACCREDITED REPRESENTATIVE IN SOUTH AFRICA FOR THE GOODS /SERVICES /WORKS OFFERED? <input type="checkbox"/> Yes <input type="checkbox"/> No [IF YES ENCLOSE PROOF]	ARE YOU A FOREIGN BASED SUPPLIER FOR THE GOODS /SERVICES /WORKS OFFERED? <input type="checkbox"/> Yes <input type="checkbox"/> No [IF YES, ANSWER PART B:3 ]
---	--

TOTAL NUMBER OF ITEMS OFFERED	TOTAL BID PRICE	R
-------------------------------	-----------------	---

SIGNATURE OF BIDDER	DATE
---------------------	------

**CAPACITY UNDER WHICH THIS BID IS SIGNED**

<b>BIDDING PROCEDURE ENQUIRIES MAY BE DIRECTED TO:</b>		<b>TECHNICAL INFORMATION MAY BE DIRECTED TO:</b>	
DEPARTMENT	Finance SCM	CONTACT PERSON	Mr A van Eeden
CONTACT PERSON	Mr J Harmse	TELEPHONE NUMBER	028 050 0957
TELEPHONE NUMBER	028 050 0910	FACSIMILE NUMBER	
FACSIMILE NUMBER		E-MAIL ADDRESS	mvaneeden@odm.org.za
E-MAIL ADDRESS	jharmse@odm.org.za		

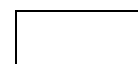

Initial

**PART B  
TERMS AND CONDITIONS FOR BIDDING**

<b>1. BID SUBMISSION:</b>	
1.1.	BIDS MUST BE DELIVERED BY THE STIPULATED TIME TO THE CORRECT ADDRESS. LATE BIDS WILL NOT BE ACCEPTED FOR CONSIDERATION.
1.2.	<b>ALL BIDS MUST BE SUBMITTED ON THE OFFICIAL FORMS PROVIDED – (NOT TO BE RE-TYPED) OR ONLINE</b>
1.3.	THIS BID IS SUBJECT TO THE PREFERENTIAL PROCUREMENT POLICY FRAMEWORK ACT AND THE PREFERENTIAL PROCUREMENT REGULATIONS, 2017, THE GENERAL CONDITIONS OF CONTRACT (GCC), OVERBERG DISTRICT MUNICIPALITY’S SUPPLY CHAIN MANAGEMENT POLICY AND, IF APPLICABLE, ANY OTHER SPECIAL CONDITIONS OF CONTRACT.
<b>2. GENERAL</b>	
2.1	BID DOCUMENTS CAN BE OBTAINED DURING OFFICE HOURS FROM MONDAY – FRIDAY: 8:00 – 13:00 AND 13:30 – 16:30, FRIDAYS: 8:00 – 13:00 AND 13:30 – 16:00 FROM THE OVERBERG DISTRICT MUNICIPALITY, SUPPLY CHAIN MANAGEMENT UNIT, 26 LONG STREET, BREDASDORP.
2.2	TELEPHONIC, FACSIMILE, ELECTRONIC/EMAILED BIDS, UNLESS STATED OTHERWISE, WILL NOT BE ACCEPTED FOR CONSIDERATION.
2.3	THE LOWEST OR ANY BID SHALL NOT NECESSARILY BE ACCEPTED AND THE COUNCIL RESERVES THE RIGHT TO ACCEPT ANY PART OF THE BID.
2.4	<b>ALL BIDS MUST BE ACCOMPANIED BY A COPY OF THE BUSINESS REGISTRATION DOCUMENTS.</b>
<b>3. TAX COMPLIANCE REQUIREMENTS</b>	
3.1	BIDDERS MUST ENSURE COMPLIANCE WITH THEIR TAX OBLIGATIONS.
3.2	BIDDERS ARE REQUIRED TO SUBMIT THEIR UNIQUE PERSONAL IDENTIFICATION NUMBER (PIN) ISSUED BY SARS TO ENABLE THE ORGAN OF STATE TO VIEW THE TAXPAYER’S PROFILE AND TAX STATUS.
3.3	APPLICATION FOR THE TAX COMPLIANCE STATUS (TCS) CERTIFICATE OR PIN MAY ALSO BE MADE VIA E-FILING. IN ORDER TO USE THIS PROVISION, TAXPAYERS WILL NEED TO REGISTER WITH SARS AS E-FILERS THROUGH THE WEBSITE WWW.SARS.GOV.ZA.
3.4	FOREIGN SUPPLIERS MUST COMPLETE THE PRE-AWARD QUESTIONNAIRE IN PART B:4.
3.5	BIDDERS MAY ALSO SUBMIT A PRINTED TCS CERTIFICATE TOGETHER WITH THE BID.
3.6	IN BIDS WHERE CONSORTIA / JOINT VENTURES / SUB-CONTRACTORS ARE INVOLVED; EACH PARTY MUST SUBMIT A SEPARATE TCS CERTIFICATE / PIN / CSD NUMBER.
3.7	WHERE NO TCS IS AVAILABLE BUT THE BIDDER IS REGISTERED ON THE CENTRAL SUPPLIER DATABASE (CSD), A CSD NUMBER MUST BE PROVIDED.
<b>4. QUESTIONNAIRE TO BIDDING FOREIGN SUPPLIERS</b>	
4.1	IS THE ENTITY A RESIDENT OF THE REPUBLIC OF SOUTH AFRICA (RSA)? <span style="float:right;"><input type="checkbox"/> YES <input type="checkbox"/> NO</span>
4.2	DOES THE ENTITY HAVE A BRANCH IN THE RSA? <span style="float:right;"><input type="checkbox"/> YES <input type="checkbox"/> NO</span>
4.3	DOES THE ENTITY HAVE A PERMANENT ESTABLISHMENT IN THE RSA? <span style="float:right;"><input type="checkbox"/> YES <input type="checkbox"/> NO</span>
4.4	DOES THE ENTITY HAVE ANY SOURCE OF INCOME IN THE RSA? <span style="float:right;"><input type="checkbox"/> YES <input type="checkbox"/> NO</span>
4.5	IS THE ENTITY LIABLE IN THE RSA FOR ANY FORM OF TAXATION? <span style="float:right;"><input type="checkbox"/> YES <input type="checkbox"/> NO</span>
IF THE ANSWER IS “NO” TO ALL OF THE ABOVE, THEN IT IS NOT A REQUIREMENT TO REGISTER FOR A TAX COMPLIANCE STATUS SYSTEM PIN CODE FROM THE SOUTH AFRICAN REVENUE SERVICE (SARS) AND IF NOT REGISTER AS PER 3.3 ABOVE.	
4.6	

**NB: FAILURE TO PROVIDE ANY OF THE ABOVE PARTICULARS MAY RENDER THE BID INVALID.  
NO BIDS WILL BE CONSIDERED FROM PERSONS IN THE SERVICE OF THE STATE.**

SIGNATURE OF BIDDER:

CAPACITY UNDER WHICH THIS BID IS SIGNED:

DATE:

.....

.....

.....

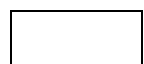

Initial

**OVERBERG DISTRICT MUNICIPALITY****SUPPLY AND DELIVERY OF GUARDRAIL BASEPLATES OR SUPPORTS**

Overberg District Municipality is currently awaiting quotations for the supply and delivery of guardrail baseplates or supports.

Enquiries regarding the technical specifications for this quotation may be directed to Mr. A Van Eeden at 028 050 0957 or email: mvaneeden@odm.org.za

Formal Quotation documents are available from Mr J Harmse at Tel: 028 050 910 or e-mail: jharmse@odm.org.za or Ms D Kapot-Witbooi at Tel: 028 050 0961 or e-mail: dkapot@odm.org.za

Sealed envelope endorsed "Q17-2020/21": SUPPLY AND DELIVERY OF GUARDRAIL BASEPLATES OR SUPPORTS must be placed in the tender box at the Municipal Offices, 26 Long Street, Bredasdorp, 7280 not later than 12:00 on Tuesday, 22 June 2021. Quotations will be opened in public thereafter.

Quotations submitted by fax, e-mail, or received after the closing time and date shall not be accepted. Quotations may only be submitted on the prescribed official document.

Overberg District Municipality shall apply its Municipal Supply Chain Management Policy as adopted in terms of section 111 of the Local Government Municipal Finance Management Act, 2003 (Act No 56 of 2003) and the relevant regulations. Quotations will be evaluated according to the criteria and weight of the 80/20 preferential procurement system. Bidders must submit a valid Tax Compliance status PIN, issued by the South African Revenue Services.

It is the prerogative of the municipality not to accept the lowest, a part of or any quotation at all.

**DP BERETTI**  
**MUNICIPAL MANAGER**

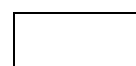

Initial

## GENERAL BID CONDITIONS AND INFORMATION

1. The Overberg District Municipality is not bound to accept the lowest, a part or any quotation at all.
2. No bid documents per fax, e-mail or late bid documents will be accepted.
3. Only bids submitted, which includes the attached formal quotation forms will be valid.
4. Payment will be made within 30 days of date of invoice.
5. All bids must be accompanied by a valid Tax Compliance Status Pin Issued and a copy of the company's latest municipal account (not older than 3 months), or a copy of the lease agreement if the company is leasing the property.
6. No alterations must be made to the bid documents.
7. Conditions as stipulated in the Supply Chain Management Policy of the Overberg District Municipality will apply.
8. For evaluation purposes, prospective suppliers need to attach **an original or certified copy** of a SANAS approved BBBEE verification certificate or a sworn affidavit. **(Not a photocopy of another certified copy)**
9. Bid documents must be placed in the Bid box as stipulated in the advertisement.
10. All requested relevant and/or additional documentation such as Compliance Certificates, professional registration, artisan qualification, etc., must be submitted with the bid document. Please attach requested or additional documents at the back and not in the page sequence.
11. Bidders must have their own transport (if applicable).
12. Bidders must arrange their own accommodation (if applicable)
13. **Completion of Bid Documents**
  - (a) The original bid document must be completed fully in black ink and signed by the authorised signatory to validate the proposal. All the pages must be initialled by the authorised signatory. Failure to do so may result in the invalidation of the bid which will result in the bid being non-responsive.
  - (b) Bid documents may not be retyped or altered in any way. The complete bid document must be returned. Missing pages will result in disqualification of the bid.
  - (c) Any bid document received with correction fluid (Tippex) corrections shall be disqualified.
14. **Alteration or Qualification of Bid**  
No unauthorised alteration of this set of bid documents will be allowed. Any unauthorised alteration will disqualify the proposal automatically. Any ambiguity must be cleared with the contact person for the bid before the closure date.
15. **Authorised Signatory**
  - (a) The Resolution taken by the Board of Directors, members, partners or trustees authorising the representative to submit this bid on the bidder's behalf must be attached to the bid document on submission of the quotation.
  - (b) A bid shall be eligible for consideration only if it bears the signature of the bidder or of some person duly and lawfully authorized to sign it for and on behalf of the bidder.
  - (c) If the resolution does not accompany the bid of the successful bidder, the Municipality reserves the right to obtain such document after the closing date to verify that the signatory is in order. If no such document can be obtained within a period as specified by the Municipality, the bid will be disqualified.

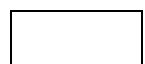

Initial



**16. Submission of Bid**

- (a) The bid must be put in a sealed envelope, or envelopes when the two-envelope system is specified, clearly marked with the bid number, title as well as closing date and time and placed in the Bid Box at the Overberg District Municipality by not later than **12h00 on 22 June 2021**.
- (b) Faxed, e-mailed and late bids will not be accepted. Bids may be delivered by hand, by courier, or posted at the bidder's risk and must be received by the deadline specified above, irrespective of how they are sent or delivered

**17. Opening, Recording and Publications of Bids Received**

- (a) Bids will be opened in public immediately after the bid closure date, or at such time as specified in the bid documents. If requested by any bidder present, the names of the bidders, and if practical the total amount of each bid and of any alternative bids will be read out aloud.

**18. Tax Compliance Status Pin Issued (TCS)**

- (a) All bids must be accompanied by a valid Tax Compliance Status Pin Issued unless the Municipality has a valid TCS of the bidder on record. The onus is on the bidder to ensure that the Overberg District Municipality has a TCS on record and obtain confirmation from the Supply Chain Management Unit of the Overberg District Municipality.
- (b) Bids not supported by a valid Tax Compliance Status Pin Issued, either as an attachment to the bid documents or on record in the case of suppliers registered on the Supplier Database of the Overberg District Municipality will be invalidated.
- (c) In bids where consortia/joint ventures/sub-contractors are involved; each partner must submit a separate valid Tax Compliance Status Pin Issued.

**19. Evaluation of Bids**

Bidders will be evaluated in terms of their responsiveness to the bid specifications and requirements as well as such additional criteria as set out in the bid document. Bidders must ensure that they adhere to the Responsiveness and Evaluation criteria (Page 14 – 18). The 80/20 preference points system will apply, where the 80 points will be used for price and the 20 points are awarded to the bidder for attaining B-BBEE status level contributor in accordance with their BEE Certificate.

**20. Acceptance or Rejection of a Bid**

The Overberg District Municipality reserves the right to withdraw any invitation to submit a bid and/or to re-advertise or to reject any bid or to accept any quotation in whole or a part of it. The Overberg District Municipality does not bind itself to accepting the lowest bid or the bid scoring the highest points.  
The Municipality reserves the right to accept more than one bid (in the event of a number of items being offered).

**21. Registration on Accredited Supplier Database & Central Supplier Database (CSD)**

It is expected of all prospective service providers who are not yet registered on the Overberg District Municipality's Accredited Supplier Database to register without delay on the prescribed form. The Overberg District Municipality reserves the right not to award proposals to prospective suppliers who are not registered on the Database.  
The municipality is not allowed to do any business with suppliers who are not registered on the CSD.

**22. Site / Information Meetings**

No meeting to be held.

**23. Stamp and Other Duties**

The successful bidder will be liable for all duties and costs on legal documents resulting in the establishment of a contract and for the surety and retentions.

**24. Language of Contract**

The contract documents will be compiled in English and the English versions of all referred documents will be taken as applicable.

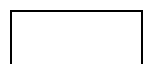

Initial

**25. Procurement Policy**

Bids will be awarded in accordance with the Municipality's Preferential Procurement Regulations Policy and the Preferential Procurement Policy Framework Act, No 5 of 2000.

**26. Expenses Incurred in Preparation of Bid**

The Overberg District Municipality shall not be liable for any expenses incurred in the preparation and submission of the bid.

**27. Wrong Information Furnished**

Where a contract has been awarded on the strength of the information furnished by the bidder which, after the conclusion of the relevant agreement, is proved to have been incorrect, the Overberg District Municipality may, in addition to any other legal remedy it may have, recover from the contractor all costs, losses or damages incurred or sustained by the Municipality as a result of the award of the contract.

**28. Validity Period**

Bids shall remain valid and available for ninety (90) days calculating from the closing date as advertised for the bid, for acceptance, or non-acceptance by the Municipality. The bidder undertakes not to withdraw, or alter, the bid during this period.

**29. General and Special Conditions of Contract**

The General Conditions of Contract as well as any Special Conditions of Contract that may form part of this set of bid documents will be applicable to this bid in addition to the conditions of bid.

**30. Municipal Rates, Taxes and Charges**

Any bidder which is or whose directors are in arrears with their municipal rates and taxes or municipal charges due to the Overberg District Municipality or any of its entities for more than three months and have not made an arrangement for settlement of same before the bid closure date will be disqualified.

**31. Contact with Municipality after Bid Closure Date**

Bidders shall not contact the Overberg District Municipality on any matter relating to their bid from the time of the opening of the bid to the time the contract is awarded. If a bidder wishes to bring additional information to the notice of the Overberg District Municipality, it should do so in writing to the Overberg District Municipality. Any effort by the firm to influence the Overberg District Municipality in the bid evaluation, bid comparison or contract award decisions may result in the rejection of the bid.

**32. Extension of Contract**

The contract with the successful bidder may be extended should additional funds become available.

**33. Past Practices**

The bid of any bidder may be rejected if that bidder or any of its directors have abused the municipality's supply chain management system or committed any improper conduct in relation to such system. The bid of any bidder may be rejected if it is or has been found that that bidder or any of its directors influenced or tried to influence any official or councillor with this or any past bid. The bid of any bidder may be rejected if it is or has been found that that bidder or any of its directors offered, promised or granted any official or any of his/her close family members, partners or associates any reward, gift, favors, hospitality or any other benefit in any improper way, with this or any past quotation.

Initial

#### 34. B-BBEE Contributor Certificate / Sworn Affidavit

(a) Notice 29617 of 2007, amendment of the Code of Good Practice, published in Government Gazette No. 29617 on 9 February 2007 in terms of the Broad-Based Black Economic Empowerment Act (Act No.53 of 2003), inter alia determines that:

- any enterprise with an annual Total Revenue of R5 million or less qualifies as an Exempted Micro-Enterprise, provided that sufficient evidence of qualification as an EME is certified in an auditor's certificate or similar certificate issued by an accounting officer or verifying agency.
- any enterprise with an annual Total Revenue of between R5 million and R35 million qualifies as a Qualifying Small Enterprise, provided that such a QSE must select any four of the seven Elements of B-BBEE for the purposes of measurement under the Qualifying Small Enterprise Scorecard contained in Code 800 of the Act.
- a Start-up Enterprise must be measured as an EME under this statement for the first year following its formation or incorporation. This provision applies regardless of the expected total revenue of such a start-up enterprise. In order to qualify as a start-up enterprise an independent confirmation of its status must be provided and a QSE Scorecard must be submitted when bidding for any contract.

BUT – in accordance with Notice 1019 - during a Transitional Period from October 2013 to April 2015, a Measured Entity may elect to use either the provisions contained in the Statement(1) issued on 9 February 2007 OR the Statement(2) issued on 11 October 2013 – thereafter all B-BBEE compliance measurements will be in accordance with Notice 1019 of 2013.

(b) Notice 1019 of 2013, published in Government Gazette No. 36928 on 11 October 2013, whereby the revised Codes of Good Practice (the codes) was issued under section 9(1) of the Broad-Based Black Economic Empowerment Act (Act No.53 of 2003), inter alia determines that:

- any enterprise with an annual Total Revenue of R10 million or less qualifies as an Exempted Micro-Enterprise and is only required to obtain a sworn affidavit on an annual basis, confirming its Annual Total Revenue and Level of Black ownership.
- a measured Entity with an annual Total Revenue of between R10 million and R50 million qualifies as a Qualifying Small Enterprise and is only required to obtain a sworn affidavit on an annual basis, confirming its Annual Total Revenue and Level of Black ownership.
- a Start-up Enterprise must be measured as an EME under this statement for the first year following its formation or incorporation. This provision applies regardless of the expected total revenue of such a start-up enterprise. In order to qualify as a start-up enterprise an independent confirmation of its status must be provided and a QSE Scorecard must be submitted when bidding for any contract above R10 million.

(c) If the certificate was issued by a verification agency the following must be on the face of the certificate: SANAS logo, unique BVA number, must be an original certificate or certified copy of the original, **not a photo-copy of another certified copy**, the name and physical location of the bidder, the registration number and, where applicable, the VAT number of the bidder, the date of issue and date of expiry of the certificate, the certificate number for identification and reference, the scorecard that was used (for example EME, QSE or Generic), the name and / or logo of the Verification Agency, the certificate must be signed by the authorized person from the Verification Agency and the B-BBEE Status Level of Contribution obtained by the bidder.

#### **If certificate was issued by an Auditor/ Accounting Officers:**

The Accounting Officer's or Registered Auditor's letter head with full contact details, the Accounting Officer's or Registered Auditor's practice numbers, the name and the physical location of the bidder, the registration number and, where applicable, the VAT number of the bidder, the date of issue and date of expiry, the BBBEE Status Level of Contribution obtained by the measured entity, the total black shareholding and total black female shareholding, the B-BBEE Status Level of Contribution obtained by the bidder and must be an original certificate or certified copy of the original, **not a photo-copy of another certified copy**, the name and physical location of the bidder, the registration number and, where applicable, the VAT number of the bidder, the date of issue and date of expiry of the certificate, the certificate number for identification and reference, the scorecard that was used (for example EME, QSE or Generic), the name and / or logo of the Verification Agency, the certificate must be signed by the authorized person from the Verification Agency and the B-BBEE Status Level of Contribution obtained by the bidder.

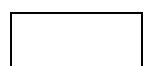

Initial

**If the certificate was issued by registered auditors approved by IRBA:**

Clearly identify the B-BBEE approved registered auditor by the auditor's individual registration number with IRBA and the auditor's logo, clearly record an approved B-BBEE Verification Certificate identification reference in the format required by the SASAE, reflect relevant information regarding the identity and location of the measured entity, identify the Codes of Good Practice or relevant Sector Codes applied in the determination of the scores, record the weighting points (scores) attained by the measured entity for each scorecard element, where applicable, and the measured entity's overall B-BBEE Status Level of Contribution, reflect that the B-BBEE Verification Certificate and accompanying assurance report issued to the measured entity is valid for 12 months from the date of issuance and reflect both the issuance and expiry date, and the B-BBEE Status Level of Contribution obtained by the bidder and must be an original certificate or a certified copy of the original, **not a photo-copy of another certified copy.**

**FAILURE TO COMPLY WITH THE ABOVEMENTIONED WILL RESULT IN NO PREFERENCE POINTS BEING AWARDED****35. Persons in the service of the state**

Any person, having a kinship with persons in the service of the state, including a blood relationship, may make an offer in terms of this invitation to bid. In view of possible allegations of favouritism, should the resulting bid, or part thereof, be awarded to persons connected with or related to persons in service of the state, it is required that the bidder or their authorised representative declare their position in relation to the evaluating/adjudicating authority and/or take an oath declaring his/her interest.

**36. Standards**

The goods supplied or the services rendered shall conform to the standards mentioned in the bidding documents and specifications.

**37. Information and Inspection**

The service provider shall not, without the District Municipality's prior written consent, disclose the agreement, or any provision thereof, or any specification, plan, drawing, pattern, sample, or information furnished by or on behalf of the District Municipality in connection therewith, to any person other than a person employed by the service provider in the performance of the agreement. Disclosure to any such employed person shall be made in confidence and shall extend only as far as may be necessary for purposes of such performance.

The service provider shall permit the Overberg District Municipality to inspect the supplier's records relating to the performance of the service provider and to have them audited by auditors appointed by the Overberg District Municipality, if so, required by the Overberg District Municipality.

**38. Governing Language**

The governing language shall be English. All correspondence and other documents pertaining to the agreement that is exchanged by the parties shall also be written in English.

**39. Payments**

Payments shall be made by the Overberg District Municipality within thirty (30) calendar days of receiving the relevant invoice provided by the supplier.

Payment will be made in Rand unless otherwise stipulated.

**40. Prices and Evaluation of bids**

Prices charged by the service provider for goods delivered and services performed under the contract shall not vary from the prices quoted by the service provider in this quotation.

The Bidder will be liable to take out forward cover to barricade him/her against fluctuation of the exchange rate in the event of importing any component, related to the quotation, from a country dealing in currency other than that of South Africa.

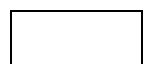

Initial

**THIS BID WILL BE EVALUATED AND ADJUDICATED ACCORDING TO THE FOLLOWING:**

- Relevant specifications
- Value for money
- Capability to execute the contract
- PPPFA & associated regulations

**41. Termination for default**

The Overberg District Municipality, without prejudice to any other remedy for breach of contract, by written notice of default sent to the service provider, may terminate this agreement in whole or in part:

If the service provider fails to deliver any or all of the goods within the period(s) specified in the agreement;

If the service provider fails to perform any obligation(s) under the contract; or

If the service provider in the judgment of the Overberg District Municipality, has engaged in corrupt or fraudulent practices in competing for or in executing the contract

In the event that the Overberg District Municipality terminates the contract in whole or in part, the Overberg District Municipality may procure, upon such terms and in such manner as it deems appropriate, goods, works or services similar to those undelivered, and the service provider shall be liable to the Overberg District Municipality for any excess costs for such similar goods, works or services. However, the service provider shall continue performance of the contract to the extent not terminated.

Where the Overberg District Municipality terminates the contract in whole or in part, the Overberg District Municipality may decide to impose a restriction penalty on the service provider by prohibiting such service provider from doing business with the public sector for a period not exceeding 10 years.

If the Overberg District Municipality intends imposing a restriction on a service provider or any person associated with the service provider, the service provider will be allowed a time period of not more than fourteen (14) days to provide reasons why the envisaged restriction should not be imposed. Should the service provider fail to respond within the stipulated fourteen (14) days the Overberg District Municipality may regard the service provider as having no objection and proceed with the restriction.

Any restriction imposed on any person by the Overberg District Municipality will, at the discretion of the Overberg District Municipality, also be applicable to any other enterprise or any partner, manager, director or other person who wholly or partly exercises or exercised or may exercise control over the enterprise of the first-mentioned person, and with which enterprise or person the first-mentioned person, is or was in the opinion of the Overberg District Municipality actively associated.

If a restriction is imposed, the Overberg District Municipality must, within five (5) working days of such imposition, furnish the National Treasury, with the following information:

- The name and address of the supplier and / or person restricted by the Overberg District Municipality;
- The date of commencement of the restriction;
- The period of restriction; and
- The reasons for the restriction

These details will be loaded in the National Treasury's central database of service provider or persons prohibited from doing business with the public sector.

If a court of law convicts a person of an offence as contemplated in sections 12 or 13 of the Prevention and Combating of Corrupt Activities Act, No. 12 of 2004, the court may also rule that such person's name be endorsed on the Register for Tender Defaulters. When a person's name has been endorsed on the Register, the person will be prohibited from doing business with the public sector for a period not less than five years and not more than 10 years. The National Treasury is empowered to determine the period of restriction and each case will be dealt with on its own merits. According to section 32 of the Act the Register must be open to the public. The Register can be perused on the National Treasury website.

**42. Termination for Insolvency**

The Overberg District Municipality may at any time terminate the contract by giving written notice to the service provider if the service provider becomes bankrupt or otherwise insolvent. In this event, termination will be without compensation to the service provider, provided that such termination will not prejudice or affect any right of action or remedy which has accrued or will accrue thereafter to the Overberg District Municipality.

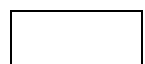

Initial

**43. Settlement of Disputes**

If any dispute or difference of any kind whatsoever arises between the Overberg District Municipality and the service provider in connection with or arising out of the contract, the parties shall make every effort to resolve amicably such dispute or difference by mutual consultation.

If, after thirty (30) days, the parties have failed to resolve their dispute or difference by such mutual consultation, then either the Overberg District Municipality or the service provider may give notice to the other party of their intention to commence with mediation. No mediation in respect of this matter may be commenced unless such notice is given to the other party.

Should it not be possible to settle a dispute by means of mediation, it may be settled in a South African court of law.

Notwithstanding any reference to mediation and/or court proceedings herein, the parties shall continue to perform their respective obligations under the contract unless they otherwise agree; and

The Overberg District Municipality shall pay the service provider any monies due for goods delivered and/or services rendered according to the prescripts of the contract.

**44. Applicable Law**

The contract shall be interpreted in accordance with South African laws, unless otherwise specified.

**45. Notices**

Every written acceptance of a bid and any other notices shall be posted to the service provider concerned by ordinary mail to the address furnished in his bid or to the address notified later by him in writing and such posting shall be deemed to be proper service of such notice;

The time mentioned in the contract documents for performing any act after such aforesaid notice has been given, shall be reckoned from the date of posting of such notice.

**46. Taxes and duties**

A service provider shall be entirely responsible for all taxes, duties, license fees, etc., of the contracted goods to the Overberg District Municipality.

No contract shall be concluded with any bidder whose tax matters are not in order.

No contract shall be concluded with any bidder whose municipal rates and taxes and municipal services charges are in arrears.

**47. Value-added tax (VAT) on invoices**

Tax invoices are to comply with the requirements as contained in the Value Added Tax Act, 1991 (Act No 89 of 1991). The content of the invoice must contain information as prescribed by the Act. It is a requirement of this contract that the amount of value-added tax (VAT) must be shown clearly on each invoice. The amended Value Added Tax Act, 1991 (Act No 89 of 1991) requires that a Tax Invoice for supplies in excess of R3,000 should, in addition to the other required information, also disclose the VAT registration number of the recipient, with effect from 1 March 2005. The VAT registration number of the Overberg District Municipality is 4610114409.

**16. Construction Industry Development Board (CIDB) (If applicable)**

When applicable, the bidder's CIDB registration number must be included with the tender. The Municipality will verify the bidder's CIDB registration during the evaluation process.

Initial

**TERMS OF REFERENCE / SCOPE OF WORK****Purpose**

The purpose of this quotation is to appoint a suitable service provider for the supply and delivery of 40 x guardrail baseplates or supports to Bredasdorp.

**Items**

- Standard plan attached as Annexure C (see detail A and section X-X)
- Supply 40 x guardrail baseplates or supports.
- Delivered to Bredasdorp Roads Depot.

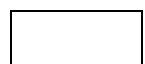

Initial

**DETAILS OF BIDDER**

Name of firm / entity / enterprise			
Trading as (if different from above)			
Postal address			
Physical address			
Contact Details of the <b>Person Signing the Bid:</b>	Name: _____ Telephone: _____ Fax: _____ Cellular Telephone: _____ e-mail address: _____		
Contact Details of the <b>Senior Manager Responsible for Overseeing Contract Performance:</b>	Name: _____ Telephone: _____ Fax: _____ Cellular Telephone: _____ e-mail address: _____		
Contact Details of the Bidder proposed <b>Project Manager who will represent the Bidder in the implementation processes:</b>	Name: _____ Telephone: _____ Fax: _____ Cellular Telephone: _____ e-mail address: _____		
Company Income Tax no.		Tax Compliance Status PIN	
VAT registration no.		CSD Registration Number	
Company registration no.			
Any other Registration applicable to this Industry			
Banking Details of Bidder	Name of Account holder: _____ Name of Bank: _____ Account Number: _____ Branch Code: _____		

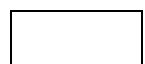

Initial



**PREVIOUS EXPERIENCE**

Indication of Competence / Ability to Perform Successfully

**Does your company have previous experience with regards to goods supplied or services rendered with reference to this formal quotation?**

<b>Yes</b>		If yes, please elaborate using the table below & complete the signatory section at the bottom of the page
<b>No</b>		If no, please complete the signatory section at the bottom of the page

**KINDLY NOTE THAT THE REFERENCES PROVIDED BELOW WILL BE CONTACTED TO VERIFY THE WORK DONE**

<b>LIST OF RECENT AND PREVIOUS WORK DONE FOR ORGANS OF STATE.</b>					
	<b>1</b>	<b>2</b>	<b>3</b>	<b>4</b>	<b>5</b>
<b>DESCRIPTION OF PROJECT</b>					
<b>CLIENT CONTACT DETAILS – Name of Client</b>					
<b>Name of Responsible Official</b>					
<b>Telephone number</b>					
<b>Valid Email Address</b>					
<b>Value of Contract</b>					
<b>Year Completed</b>					

Signed at ..... on this .....day of ..... 20.....

As Witnesses: 1).....

2).....

.....  
SIGNATURE OF BIDDER

Initial

**AUTHORITY OF SIGNATORY**

Indicate the status of the bidder by ticking the appropriate box hereunder. The bidder must complete the certificate set out below for the relevant category.

A Company	B Partnership	C Sole Proprietor	D Joint Venture	E Close Corporation

**A. Certificate for company**

I, ....., chairperson of the board of directors of ....., hereby confirm that by resolution of the board (copy attached) taken on ..... 20..... Mr/Mrs ..... acting in the capacity of ....., was authorised to sign all documents in connection with this quotation and any contract resulting from it on behalf of the company.

As witness

1.....  
Chairman

2.....  
Date

**B. Certificate of partnership**

We, the undersigned, being the key partners in the business trading as ..... hereby authorise Mr/Mrs ..... acting in the capacity of ..... to sign all documents in connection with the quotation for contract ..... and any contract resulting from it on our behalf.

NAME	ADDRESS	SIGNATURE	DATE

NOTE: This certificate is to be completed and signed by all of the key partners upon who rests the direction of the affairs of the Partnership as a whole.

**C. Certificate for sole proprietor**

I, ....., hereby confirm that I am the sole owner of the business trading as.....

As Witness:

1.....  
Signature: Sole owner

2.....  
Date

Initial

**D. Certificate for Joint Venture**

We, the undersigned, are submitting this quotation offer in Joint Venture and hereby authorise Mr/Mrs ..... authorised signatory of the company ..... acting in the capacity of lead partner, to sign all documents in connection with the quotation offer for contract ..... and any other contract resulting from it on our behalf.

This authorisation is evidenced by the attached power of attorney signed by legally authorised signatories of all the partners to the Joint Venture.

NAME OF FIRM	ADDRESS	AUTHORISING SIGNATURE, NAME & CAPACITY
Lead partner		

**E. Certificate for Close Corporation**

We, the undersigned, being the key members in the business trading as ..... hereby authorise Mr/Mrs ..... acting in the capacity of ..... to sign all documents in connection with the quotation for contract ..... and any contract resulting from it on our behalf.

NAME	ADDRESS	SIGNATURE	DATE

**NOTE:** This certificate is to be complete and signed by all the key members upon whom rests the direction of the affairs of the Close Corporation as a whole.

Initial

**COMPULSORY ENTERPRISE QUESTIONNAIRE**

The following particulars **must** be furnished. In the case of a joint venture, separate enterprise questionnaires in respect of each partner must be completed and submitted.

**Section 1: Enterprise details**

<b>Name of enterprise</b>	
<b>Contact Person</b>	
<b>Email</b>	
<b>Telephone</b>	
<b>Cellphone</b>	
<b>Fax</b>	
<b>Physical Address</b>	
<b>Postal Address</b>	
<b>Central supplier database registration number</b>	MAAA

**Section 2: Particulars of companies and close corporations**

<b>Company / Close Corporation registration number:</b>	
---	--

**Section 3: SARS information:**

<b>Tax reference number:</b>	
<b>VAT registration number, if any:</b>	

**Section 4: CIDB registration number: N/A**

**Section 5: Particulars of principles**

**Principle:** means a natural person who is a partner in partnership, a sole proprietor, a director of a company established in terms of the Companies Act of 2008 (Act. No. 71 of 2008) a member of a close corporation registered in terms of the Close Corporation Act, 1984 (Act No.69 of 1984)

Full name of principal	Identity number*	Personal income tax number*

\* Please complete and attach copies of Identity documents.

**Section 6: Banking Details of companies and close corporations**

Bank name and branch: .....

Bank account number: .....

Name of account holder: .....

Signed ..... Date .....

Name ..... Position .....

Tenderer .....

Initial

## DOCUMENTS OF INCORPORATION (CK2)

The bidder **must** attach to this page a copy of the certificate of incorporation of his/her company, close corporation or partnership. In the case of a joint venture between two or more firms, the bidder shall attach a copy of the document of incorporation of the joint venture.

Signed .....

Date .....

Name .....

Position .....

Bidder .....

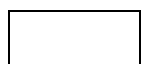

Initial

### TAX COMPLIANCE STATUS

It is a condition of bid that the taxes of the successful bidder must be in order, or that satisfactory arrangements have been made with South African Revenue Service (SARS) to meet the bidder's tax obligations.

- 1 In order to meet this requirement bidders are required to request their Tax Compliance Status which will include a unique PIN which you can provide to any third party (**if requested**) to enable them to verify your tax compliance status online via eFiling.
- 2 Request a TCS via eFiling which will give you the option to print the TCS or request a TCS at a SARS branch where a SARS agent will be able to print or email the TCS to you.
- 3 The Tax Compliance Status Requirements are also applicable to foreign bidders / individuals who wish to submit bids.
- 4 A **Tax Compliance Status** is a holistic view of your tax compliance level across all your registered tax types.
- 5 If your tax compliance status is compliant, the SARS agent will be able to print or email you your TCS to the registered email address which SARS has on record for you.
- 6 **Please note:** If your tax compliance status reflects that you are non-compliant, you will not receive a TCS until you have rectified your compliance.
- 7 The **Printed Tax Compliance Status Pin Issued must** be submitted together with the bid. **Failure to submit** a Tax Compliance Status pin **will result in the invalidation of the quotation.**
- 8 In bids where Consortia / Joint Ventures / Sub-contractors are involved; each party must submit a separate printed **Tax Compliance Pin**.
- 9 **Please note that not all government institutions and private organisations will be able to utilise the Tax Compliance Status PIN at this stage and in such instances, you must supply a printed TCS. It is envisaged that the PIN will, in time, replace the paper TCS.**

	YES	NO
Is your company already registered on the Overberg District Municipality's (ODM) Database?		
Have you confirmed this with the Supply Chain Management Department of ODM		
If yes, please provide ODM Database Supplier Number.		

As stated above, bidders must ensure that they are up to date with payments of taxes.

The bidder **must** attach to this page a **Tax Compliance status pin** as issued by the South African Revenue Service.

**Failure to submit** a Tax Compliance status pin **will result in the invalidation of the quotation.**

Signed ..... Date .....

Name ..... Position .....

Bidder .....

Initial

## PRICING SCHEDULE

Name of Bidder: _____	Bid Number: Q17-2020/21
Closing Time: 12:00	Closing Date: 22 June 2021

OFFER TO BE VALID FOR 90 DAYS FROM THE CLOSING DATE OF BID.

**FOR PROPER EVALUATION PURPOSES IT IS ESSENTIAL THAT THIS SPECIFIC PRICING SCHEDULE BE COMPLETED. ALTERNATIVE PRICING SCHEDULES WILL NOT BE ACCEPTED.**

Item	Description	Total Price (incl. Vat)
1	40 x guardrail baseplates or supports.	
	<b>Delivery - Bredasdorp Roads Depot.</b>	
<b>TOTAL PRICE (incl. VAT)</b>		

Address of Office: .....

The quantities as indicated in the pricing schedule are only estimates which will be used in order to evaluate the bid. The unit prices as quoted above must remain fixed for the duration of the contract.

Required by **Mr A van Eeden**  
 Does offer comply with specification? \*YES/NO  
 If not to specification, indicate deviation(s) .....  
 Period required for delivery .....  
 \*Delivery date: Firm/not firm .....  
 Note: All costs must be included in the bid price.

**Note: All costs must be included in the bid price and delivered to the prescribed destination**

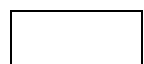

Initial

**COMPULSORY TO COMPLETE**

**QUOTATION NO: Q17-2020/21**

**SUPPLY AND DELIVERY OF GUARDRAIL BASEPLATES OR SUPPORTS**

**FORM OF OFFER AND ACCEPTANCE**

**OFFER**

The Employer, identified in the acceptance signature block, has solicited offers to enter into a contract for the procurement of:

**Q17-2020/21: SUPPLY AND DELIVERY OF GUARDRAIL BASEPLATES OR SUPPORTS**

The Supplier, identified in the acceptance signature block, has examined the documents listed in the tender data and addenda thereto as listed in the returnable schedules, and by submitting this offer has accepted the conditions of tender.

By the representative of the Supplier, deemed to be duly authorized, signing this part of this form of offer and acceptance, the Supplier offers to perform all the obligations and liabilities of the contractor under the contract, including compliance with all its terms and conditions according to their true intent and meaning for an amount to be determined in accordance with the conditions of quotation identified in the quotation data.

**AS PER PRICING SCHEDULE MBD 3.1 (ALTERNATIVE PRICING SCHEDULES WILL NOT BE ACCEPTED)**

This offer may be accepted by the employer by signing the acceptance part of this form of offer and acceptance and returning one copy of this document to the tender supplier before the end of the period of validity stated in the quotation data, whereupon the tender supplier becomes the party named as the contractor in the contract identified in the tender data.

Signature(s) .....

Name(s) .....

Capacity .....

Company Name .....

Address .....

.....

.....

.....

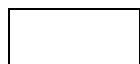

Initial



**\*NB: This form to be completed by the ODM.**

**QUOTATION NO: Q17-2020/21**

**SUPPLY AND DELIVERY OF GUARDRAIL BASEPLATES OR SUPPORTS**

**ACCEPTANCE**

By signing this part of the form of offer and acceptance, the employer identified below accepts the Tender supplier's offer. In consideration thereof, the employer shall pay the tender supplier the amount due in accordance with the conditions of quote identified in the tender data. Acceptance of the tender supplier's offer shall form an agreement between the employer and the tender supplier upon the terms and conditions contained in this agreement and in the contract that is the subject of this agreement.

Notwithstanding anything contained herein, this agreement comes into effect on the date when the tender supplier receives one fully completed original copy of this document, including the schedule of deviations (if any). Unless the tender supplier within five working days of the date of such receipt notifies the employer in writing of any reason why he cannot accept the contents of this agreement, this agreement shall constitute a binding contract between the parties.

Signature(s) .....

Name(s) .....

Capacity .....

For the  
Employer .....

.....  
(Name and Address of Organization)

Date: .....

Initial

**DECLARATION OF INTEREST**

- 1. No bid will be accepted from persons in the service of the state<sup>1</sup>.
- 2. Any person, having a kinship with persons in the service of the state, including a blood relationship, may make an offer or offers in terms of this invitation to bid. In view of possible allegations of favouritism, should the resulting bid, or part thereof, be awarded to persons connected with or related to persons in service of the state, it is required that the bidder or their authorised representative declare their position in relation to the evaluating/adjudicating authority

**3 In order to give effect to the above, the following questionnaire must be completed and submitted with the bid.**

- 3.1 Full Name of bidder or his or her representative: .....
- 3.2 Identity Number: .....
- 3.3 Position occupied in the Company (director, trustee, shareholder<sup>2</sup>).....
- 3.4 Company Registration Number: .....
- 3.5 Tax Reference Number: .....
- 3.6 VAT Registration Number: .....
- 3.7 The names of all directors / trustees / shareholders members, their individual identity numbers and state employee numbers must be indicated in paragraph 4 below.
- 3.8 Are you presently in the service of the state? **YES / NO**
- 3.8.1 If yes so, furnish particulars.....  
.....

<sup>1</sup>MSCM Regulations: "in the service of the state" means to be –

- (a) a member of –
  - (i) any municipal council;
  - (ii) any provincial legislature; or
  - (iii) the national Assembly or the national Council of provinces;
- (b) a member of the board of directors of any municipal entity;
- (c) an official of any municipality or municipal entity;
- (d) an employee of any national or provincial department, national or provincial public entity or constitutional institution within the meaning of the Public Finance Management Act, 1999 (Act No.1 of 1999);
- (e) a member of the accounting authority of any national or provincial public entity; or
- (f) an employee of Parliament or a provincial legislature.

<sup>2</sup>Shareholder – means a person who owns shares in the company and is actively involved in the management of the company or business and exercise control over the company.

Initial

3.9 Have you been in the service of the state for the past twelve months? **YES / NO**

3.9.1 If yes so, furnish particulars.....

**Section 3.9.1: Record of service of the state**

Indicate by marking the relevant boxes with a cross, if any sole proprietor, partner in a partnership or director, manager, principal shareholder or stakeholder in a company or close corporation is currently or has been within the last 12 months in the service of any of the following:

<input type="checkbox"/> a member of any municipal council	<input type="checkbox"/> an employee of any provincial department, national or provincial public entity or constitutional institution within the meaning of the Public Finance Management Act, 1999 (Act 1 of 1999)
<input type="checkbox"/> a member of any provincial legislature	<input type="checkbox"/> a member of an accounting authority of any national or provincial public entity
<input type="checkbox"/> a member of the National Assembly or the National Council of Province	<input type="checkbox"/> an employee of Parliament or a provincial legislature
<input type="checkbox"/> a member of the board of directors of any municipal entity	
<input type="checkbox"/> an official of any municipality or municipal entity	

**If any of the above boxes are marked, disclose the following:** (insert separate page if necessary)

Name of sole proprietor, partner, director, manager, principal shareholder or stakeholder	Name of institution, public office, board or organ of state and position held	Status of service (tick appropriate column)	
		current	Within last 12 months

\* Insert separate page if necessary

3.10 Do you; have any relationship (family, friend, other) with persons in the service of the state and who may be involved with the evaluation and or adjudication of this bid? **YES / NO**

3.10.1 If yes so, furnish particulars.....

3.11 Are you, aware of any relationship (family, friend, other) between a bidder and any persons in the service of the state who may be involved with the evaluation and or adjudication of this bid? **YES / NO**

3.11.1 If yes so, furnish particulars.....

3.12 Are any of the company's directors, managers, principle shareholders or stakeholders in service of the state? **YES / NO**

3.12.1 If yes so, furnish particulars.....

Initial

3.13 Are any spouse, child or parent of the company's directors, managers, principle shareholders or stakeholders in service of the state?

**YES / NO**

3.13.1 If yes so, furnish particulars: .....

Name of the company's director / manager / principle shareholder and/or stakeholder	Full name of family member	Relationship	Name of the organization (Organ of State)	Capacity (Designation) in which family member is in at OOS*

*\*Organ of State*

3.14 Do you or any of the directors, trustees, managers, principle shareholders, or stakeholders of this company have any interest in any other related companies or business whether or not they are bidding for this contract.

**YES / NO**

3.14.1 If yes so, furnish particulars.....

.....

Initial



## RESPONSIVENESS AND EVALUATION CRITERIA

**NB:** Overberg District Municipality may verify any information submitted in terms of this proposal and any information that is incorrect may result in that Bid being automatically disqualified and not considered further.

### RESPONSIVENESS CRITERIA

No bid will be considered by Overberg District Municipality unless it meets the following responsiveness criteria (for the bid to be considered responsive, the bid **must** meet the following requirements):

1. The bid must be properly received in a sealed envelope clearly indicating the description of the service and the bid number for which the bid is submitted.
2. The bid must be deposited in the relevant Bid box as indicated on the notice of the bid on or before the closing date and time of the bid. **Telephonic, facsimile, electronic/mailed and late bids will not be accepted.**
3. A Valid Tax Compliance Status Pin Issued must be attached to the bid document. **Bidders who are registered on the municipality's accredited supplier database and attached a valid Tax Compliance Status Pin Issued to their application form does not need to submit a Tax Compliance Status Pin Issued with their bid document.**
4. The official bid document must be fully completed in indelible ink. Where information requested does not apply to the bidder and the space is left blank, it will be deemed to be not applicable.
5. **Completion of Bid Documents**
  - (a) The original bid document must be completed fully in black ink and signed by the authorized signatory to validate the proposal. **All the pages must be initialed by the authorized signatory.** Failure to do so may result in the invalidation of the bid which will result in the bid being non-responsive.
  - (b) Bid documents may not be retyped or altered in any way.
6. **Arithmetical Errors, Omissions and Discrepancies**
  - (a) Check responsive tenders for discrepancies between amounts in words and amounts in figures. Where there is a discrepancy between the amounts in figures and the amount in words, the amount in words shall govern.
  - (b) Check the highest ranked tender or tenderer with the highest number of tender evaluation points after the evaluation of tender offers in accordance with paragraph 20 for:
    - i) the gross misplacement of the decimal point in any unit rate.
    - ii) omissions made in completing the pricing schedule or bills of quantities; or
    - iii) arithmetic errors in:
      - i) line-item totals resulting from the product of a unit rate and a quantity in bills of quantities or schedules of prices; or
      - ii) the summation of the prices.
  - (c) Notify the tenderer of all errors or omissions that are identified in the tender offer and either confirm the tender offer as tendered or accept the corrected total of prices.
  - (d) Where the tenderer elects to confirm the tender offer as tendered, correct the errors as follows:
    - i) If bills of quantities or pricing schedules apply and there is an error in the line-item total resulting from the product of the unit rate and the quantity, the line-item total shall govern, and the rate shall be corrected.

Initial

7. All requested relevant and/or additional documentation such as Compliance Certificates, professional registration, artisan qualification, etc., must be submitted with the bid document. **Please indicate where in this document these attachments can be found.**
8. The bidder must complete the previous experience schedule on page 15 of the bid document in order to prove its experience.
9. Annexure A (Page 62 - 63) (Authorization to deduct outstanding amounts) must be completed and signed.
10. Annexure B (Page 64) (certificate for municipal services and payments to service provider) must be completed and signed. Bidders must submit a certified statement signed by the bidder declaring that the bidder has no undisputed commitments for municipal services towards a municipality or other service provider in respect of which payment is overdue for more than 30 days.
11. The bidder must be in good standing to do business with the public sector in terms of Regulation 38 of the Supply Chain Management Regulations (Government Gazette 27636 of 30 May 2005).
12. If the entity submitting a bid is a Joint Venture or Consortium or Partnership, each party to that formation must submit all the above information.
13. The bidder must adhere to the Pricing Instructions **MBD 3.1 (Page 22). The quantities as indicated in the pricing schedule are only estimates which will be used in order to evaluate the bid. The unit prices as quoted above must remain fixed for the duration of the contract.**
14. The Bidders Details must be provided.
15. The necessary document authorizing the Representative to sign and submit the bid on the bidder's behalf must be completed and signed (Page 17 - 18)
16. The Form of Offer must be completed and signed by the bidder (Page 23).
17. The Declaration of Interests (MBD4) by the bidder must be completed and signed. (Page 25 - 28)
18. The GCC (General Conditions of Contract) (MBD5) must be signed by the bidder (Page 32 - 43). Only the section applicable to the Bidder (Supplier).
19. MBD 8 (Declaration of bidder's past supply chain management practices) must be completed and signed
20. MBD 9 (Certificate of independent bid determination) must be completed and signed
21. The checklist at the back of the bid document must be completed and adhered to.

## EVALUATION OF BIDS

- All bids received shall be evaluated in terms of the Supply Chain Management Regulations, Preferential Procurement Policy Framework Act, SCM Policy and the Preferential Procurement Policy.
- The Council reserves the right to accept all, some, or none of the bids submitted — either wholly or in part — and it is not obligated to accept the lowest bid.
- Bids will be evaluated in terms of their responsiveness to the bid specifications and requirements as well as such additional criteria as set out in the bid documents. Bidders must ensure that they adhere to the Responsive and Evaluation Criteria (Page 29 -31)

Initial

**REGISTRATION ON ACCREDITED SUPPLIER DATABASE AND THE CENTRAL SUPPLIER DATABASE (CSD)**

- It is expected of all prospective service providers who are not yet registered on the Overberg District Municipality's Accredited Supplier Database to register without delay on the prescribed form. The Overberg District Municipality reserves the right not to award proposals to prospective suppliers who are not registered on the Database.
- Bidders must also be duly registered on the Central Supplier Database (CSD). Should you not be registered on the CSD, please self-register on [www.csd.gov.za](http://www.csd.gov.za), for further assistance please contact [csd@treasury.gov.za](mailto:csd@treasury.gov.za) or 012 315 5509
- The municipality is not allowed to do any business with suppliers who are not registered on the CSD

**REGISTRATION ON ACCREDITED SUPPLIER DATABASE AND THE CENTRAL SUPPLIER DATABASE (CSD)**

- It is expected of all prospective service providers who are not yet registered on the Overberg District Municipality's Accredited Supplier Database to register without delay on the prescribed form. The Overberg District Municipality reserves the right not to award proposals to prospective suppliers who are not registered on the Database.
- Bidders must also be duly registered on the Central Supplier Database (CSD). Should you not be registered on the CSD, please self-register on [www.csd.gov.za](http://www.csd.gov.za), for further assistance please contact [csd@treasury.gov.za](mailto:csd@treasury.gov.za) or 012 315 5509
- The municipality is not allowed to do any business with suppliers who are not registered on the CSD

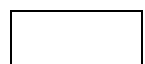

Initial



**OVERBERG DISTRICT MUNICIPALITY**



---

**GOVERNMENT PROCUREMENT:**

**GENERAL CONDITIONS OF CONTRACT (July 2010)**

**Made and entered into between:**

**Overberg District Municipality**  
(Hereinafter referred to as the "Client")

**AND**

\_\_\_\_\_  
\_\_\_\_\_  
\_\_\_\_\_

(Hereinafter referred to as the "Supplier")

Initial

**TABLE OF CLAUSES**

1. Definitions
2. Application
3. General
4. Standards
5. Use of contract documents and information inspection
6. Patent Rights
7. Performance security
8. Inspections, tests and analyses
9. Packing
10. Delivery and documents
11. Insurance
12. Transportation
13. Incidental Services
14. Spare parts
15. Warranty
16. Payment
17. Prices
18. Variation orders
19. Assignment
20. Subcontracts
21. Delays in the supplier's performance
22. Penalties
23. Termination for default
24. Anti-dumping and countervailing duties and rights
25. Force Majeure
26. Termination for insolvency
27. Settlement of Disputes
28. Limitation of Liability
29. Governing language
30. Applicable law
31. Notices
32. Taxes and duties
33. Transfer of contracts
34. Amendments of contracts

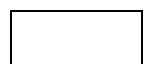

Initial

## GENERAL CONDITIONS OF CONTRACT

### 1. Definitions

The following terms shall be interpreted as indicated:

- 1.1 **"Closing time"** means the date and hour specified in the bidding documents for the receipt of bids.
- 1.2 **"Contract"** means the written agreement entered into between the purchaser and the supplier, as recorded in the contract form signed by the parties, including all attachments and appendices thereto and all documents incorporated by reference therein.
- 1.3 **"Contract price"** means the price payable to the supplier under the contract for the full and proper performance of his contractual obligations.
- 1.4 **"Corrupt practice"** means the offering, giving, receiving, or soliciting of anything of value to influence the action of a public official in the procurement process or in contract execution.
- 1.5 **"Countervailing duties"** are imposed in cases where an enterprise abroad is subsidized by its government and encouraged to market its products internationally.
- 1.6 **"Country of origin"** means the place where the goods were mined, grown or produced or from which the services are supplied. Goods are produced when, through manufacturing, processing or substantial and major assembly of components, a commercially recognized new product results that is substantially different in basic characteristics or in purpose or utility from its components.
- 1.7 **"Day"** means calendar day.
- 1.8 **"Delivery"** means delivery in compliance of the conditions of the contract or order.
- 1.9 **"Delivery ex stock"** means immediate delivery directly from stock actually on hand.
- 1.10 **"Delivery into consignees store or to his site"** means delivered and unloaded in the specified store or depot or on the specified site in compliance with the conditions of the contract or order, the supplier bearing all risks and charges involved until the goods are so delivered and a valid receipt is obtained.
- 1.11 **"Dumping"** occurs when a private enterprise abroad market its goods on own initiative in the RSA at lower prices than that of the country of origin and which have the potential to harm the local industries in the RSA.
- 1.12 **"Force majeure"** means an event beyond the control of the supplier and not involving the supplier's fault or negligence and not foreseeable. Such events may include, but is not restricted to, acts of the purchaser in its sovereign capacity, wars or revolutions, fires, floods, epidemics, quarantine restrictions and freight embargoes.
- 1.13 **"Fraudulent practice"** means a misrepresentation of facts in order to influence a procurement process or the execution of a contract to the detriment of any bidder, and includes collusive practice among bidders (prior to or after bid submission) designed to establish bid prices at artificial non-competitive levels and to deprive the bidder of the benefits of free and open competition.
- 1.14 **"GCC"** means the General Conditions of Contract.
- 1.15 **"Goods"** means all of the equipment, machinery, and/or other materials that the supplier is required to supply to the purchaser under the contract.

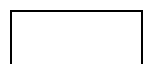

Initial

- 1.16 **“Imported content”** means that portion of the bidding price represented by the cost of components, parts or materials which have been or are still to be imported (whether by the supplier or his subcontractors) and which costs are inclusive of the costs abroad, plus freight and other direct importation costs such as landing costs, dock dues, import duty, sales duty or other similar tax or duty at the South African place of entry as well as transportation and handling charges to the factory in the Republic where the goods covered by the bid will be manufactured.
- 1.17 **“Local content”** means that portion of the bidding price, which is not included in the imported content provided that local manufacture does take place.
- 1.18 **“Manufacture”** means the production of products in a factory using labour, materials, components and machinery and includes other related value-adding activities.
- 1.19 **“Order”** means an official written order issued for the supply of goods or works or the rendering of a service.
- 1.20 **“Project site,”** where applicable, means the place indicated in bidding documents.
- 1.21 **“Purchaser”** means the organization purchasing the goods.
- 1.22 **“Republic”** means the Republic of South Africa.
- 1.23 **“SCC”** means the Special Conditions of Contract.
- 1.24 **“Services”** means those functional services ancillary to the supply of the goods, such as transportation and any other incidental services, such as installation, commissioning, provision of technical assistance, training, catering, gardening, security, maintenance and other such obligations of the supplier covered under the contract.
- 1.25 **“Supplier”** means the successful bidder who is awarded the contract to maintain and administer the required and specified service(s) to the State.
- 1.26 **“Tort”** means in breach of contract.
- 1.27 **“Turnkey”** means a procurement process where one service provider assumes total responsibility for all aspects of the project and delivers the full end product / service required by the contract.
- 1.28 **“Written” or “in writing”** means hand-written in ink or any form of electronic or mechanical writing.

## 2. Application

- 2.1 These general conditions are applicable to all bids, contracts and orders including bids for functional and professional services (excluding professional services related to the building and construction industry), sales, hiring, letting and the granting or acquiring of rights, but excluding immovable property, unless otherwise indicated in the bidding documents.
- 2.2 Where applicable, special conditions of contract are also laid down to cover specific goods, services or works.
- 2.3 Where such special conditions of contract are in conflict with these general conditions, the special conditions shall apply.

## 3. General

- 3.1 Unless otherwise indicated in the bidding documents, the purchaser shall not be liable for any expense incurred in the preparation and submission of a bid. Where applicable a non-refundable fee for documents may be charged.
- 3.2 Invitations to bid are usually published in locally distributed news media and on the municipality/municipal entity website.

## 4. Standards

- 4.1 The goods supplied shall conform to the standards mentioned in the bidding documents and specifications.

Initial

## 5. Use of contract documents and information inspection

- 5.1 The supplier shall not, without the purchaser's prior written consent, disclose the contract, or any provision thereof, or any specification, plan, drawing, pattern, sample, or information furnished by or on behalf of the purchaser in connection therewith, to any person other than a person employed by the supplier in the performance of the contract. Disclosure to any such employed person shall be made in confidence and shall extend only so far as may be necessary for purposes of such performance.
- 5.2 The supplier shall not, without the purchaser's prior written consent, make use of any document or information mentioned in GCC clause 5.1 except for purposes of performing the contract.
- 5.3 Any document, other than the contract itself mentioned in GCC clause 5.1 shall remain the property of the purchaser and shall be returned (all copies) to the purchaser on completion of the supplier's performance under the contract if so required by the purchaser.
- 5.4 The supplier shall permit the purchaser to inspect the supplier's records relating to the performance of the supplier and to have them audited by auditors appointed by the purchaser, if so required by the purchaser.

## 6. Patent Rights

- 6.1 The supplier shall indemnify the purchaser against all third-party claims of infringement of patent, trademark, or industrial design rights arising from use of the goods or any part thereof by the purchaser.
- 6.2 When a supplier developed documentation / projects for the municipality / municipal entity, the intellectual, copy and patent rights or ownership of such documents or projects will vest in the municipality / municipal entity.

## 7. Performance security

- 7.1 Within thirty (30) days of receipt of the notification of contract award, the successful bidder shall furnish to the purchaser the performance security of the amount specified in SCC.
- 7.2 The proceeds of the performance security shall be payable to the purchaser as compensation for any loss resulting from the supplier's failure to complete his obligations under the contract.
- 7.3 The performance security shall be denominated in the currency of the contract or in a freely convertible currency acceptable to the purchaser and shall be in one of the following forms:
- (a) a bank guarantee or an irrevocable letter of credit issued by a reputable bank located in the purchaser's country or abroad, acceptable to the purchaser, in the form provided in the bidding documents or another form acceptable to the purchaser; or
- (b) a cashier's or certified cheque.
- 7.4 The performance security will be discharged by the purchaser and returned to the supplier not later than thirty (30) days following the date of completion of the supplier's performance obligations under the contract, including any warranty obligations, unless otherwise specified.

## 8. Inspections, tests and analyses

- 8.1 All pre-bidding testing will be for the account of the bidder.
- 8.2 If it is a bid condition that goods to be produced or services to be rendered should at any stage be subject to inspections, tests and analyses, the bidder or contractor's premises shall be open, at all reasonable hours, for inspection by a representative of the purchaser or organization acting on behalf of the purchaser.

Initial

- 8.3 If there are no inspection requirements indicated in the bidding documents and no mention is made in the contract, but during the contract period it is decided that inspections shall be carried out, the purchaser shall itself make the necessary arrangements, including payment arrangements with the testing authority concerned.
- 8.4 If the inspections, tests and analyses referred to in clauses 8.2 and 8.3 show the goods to be in accordance with the contract requirements, the cost of the inspections, tests and analyses shall be defrayed by the purchaser.
- 8.5 Where the goods or services referred to in clauses 8.2 and 8.3 do not comply with the contract requirements, irrespective of whether such goods or services are accepted or not, the cost in connection with these inspections, tests or analyses shall be defrayed by the supplier.
- 8.6 Goods and services which are referred to in clauses 8.2 and 8.3 and which do not comply with the contract requirements may be rejected.
- 8.7 Any contract goods may on or after delivery be inspected, tested or analysed and may be rejected if found not to comply with the requirements of the contract. Such rejected goods shall be held at the cost and risk of the supplier who shall, when called upon, remove them immediately at his own cost and forthwith substitute them with goods, which do comply with the requirements of the contract. Failing such removal the rejected goods shall be returned at the suppliers cost and risk. Should the supplier fail to provide the substitute goods forthwith, the purchaser may, without giving the supplier further opportunity to substitute the rejected goods, purchase such goods as may be necessary at the expense of the supplier.
- 8.8 The provisions of clauses 8.4 to 8.7 shall not prejudice the right of the purchaser to cancel the contract on account of a breach of the conditions thereof, or to act in terms of Clause 22 of GCC.

## **9. Packing**

- 9.1 The supplier shall provide such packing of the goods as is required to prevent their damage or deterioration during transit to their final destination, as indicated in the contract. The packing shall be sufficient to withstand, without limitation, rough handling during transit and exposure to extreme temperatures, salt and precipitation during transit, and open storage. Packing, case size weights shall take into consideration, where appropriate, the remoteness of the goods' final destination and the absence of heavy handling facilities at all points in transit.
- 9.2 The packing, marking, and documentation within and outside the packages shall comply strictly with such special requirements as shall be expressly provided for in the contract, including additional requirements, if any, and in any subsequent instructions ordered by the purchaser.

## **10. Delivery and documents**

- 10.1 Delivery of the goods and arrangements for shipping and clearance obligations, shall be made by the supplier in accordance with the terms specified in the contract.

## **11. Insurance**

- 11.1 The goods supplied under the contract shall be fully insured in a freely convertible currency against loss or damage incidental to manufacture or acquisition, transportation, storage and delivery in the manner specified.

## **12. Transportation**

- 12.1 Should a price other than an all-inclusive delivered price be required, this shall be specified.

## **13. Incidental Services**

- 13.1 The supplier may be required to provide any or all of the following services, including additional services, if any:

(a) Performance or supervision of on-site assembly and/or commissioning of the supplied goods;

Initial

- (b) Furnishing of tools required for assembly and/or maintenance of the supplied goods;
- (c) Furnishing of a detailed operations and maintenance manual for each appropriate unit of the supplied goods;
- (d) Performance or supervision or maintenance and/or repair of the supplied goods, for a period of time agreed by the parties, provided that this service shall not relieve the supplier of any warranty obligations under this contract; and
- (e) Training of the purchaser's personnel, at the supplier's plant and/or on-site, in assembly, start-up, operation, maintenance, and/or repair of the supplied goods.

13.2 Prices charged by the supplier for incidental services, if not included in the contract price for the goods, shall be agreed upon in advance by the parties and shall not exceed the prevailing rates charged to other parties by the supplier for similar services.

#### **14. Spare parts**

14.1 As specified, the supplier may be required to provide any or all of the following materials, notifications, and information pertaining to spare parts manufactured or distributed by the supplier:

- (a) Such spare parts as the purchaser may elect to purchase from the supplier, provided that this election shall not relieve the supplier of any warranty obligations under the contract; and
- (b) In the event of termination of production of the spare parts:
  - (i) Advance notification to the purchaser of the pending termination, in sufficient time to permit the purchaser to procure needed requirements; and
  - (ii) Following such termination, furnishing at no cost to the purchaser, the blueprints, drawings, and specifications of the spare parts, if requested.

#### **15. Warranty**

15.1 The supplier warrants that the goods supplied under the contract are new, unused, of the most recent or current models, and that they incorporate all recent improvements in design and materials unless provided otherwise in the contract. The supplier further warrants that all goods supplied under this contract shall have no defect, arising from design, materials, or workmanship (except when the design and/or material is required by the purchaser's specifications) or from any act or omission of the supplier, that may develop under normal use of the supplied goods in the conditions prevailing in the country of final destination.

15.2 This warranty shall remain valid for twelve (12) months after the goods, or any portion thereof as the case may be, have been delivered to and accepted at the final destination indicated in the contract, or for eighteen (18) months after the date of shipment from the port or place of loading in the source country, whichever period concludes earlier, unless specified otherwise.

15.3 The purchaser shall promptly notify the supplier in writing of any claims arising under this warranty.

15.4 Upon receipt of such notice, the supplier shall, within the period specified and with all reasonable speed, repair or replace the defective goods or parts thereof, without costs to the purchaser.

15.5 If the supplier, having been notified, fails to remedy the defect(s) within the period specified, the purchaser may proceed to take such remedial action as may be necessary, at the supplier's risk and expense and without prejudice to any other rights which the purchaser may have against the supplier under the contract.

Initial

**16. Payment**

- 16.1 The method and conditions of payment to be made to the supplier under this contract shall be specified.
- 16.2 The supplier shall furnish the purchaser with an invoice accompanied by a copy of the delivery note and upon fulfilment of other obligations stipulated in the contract.
- 16.3 Payments shall be made promptly by the purchaser, but in no case later than thirty (30) days after submission of an invoice or claim by the supplier.
- 16.4 Payment will be made in Rand unless otherwise stipulated.

**17. Prices**

- 17.1 Prices charged by the supplier for goods delivered and services performed under the contract shall not vary from the prices quoted by the supplier in his bid, with the exception of any price adjustments authorized or in the purchaser's request for bid validity extension, as the case may be.

**18. Variation orders**

- 18.1 In cases where the estimated value of the envisaged changes in purchase does not vary more than 15% of the total value of the original contract, the contractor may be instructed to deliver the goods or render the services as such. In cases of measurable quantities, the contractor may be approached to reduce the unit price, and such offers may be accepted provided that there is no escalation in price.

**19. Assignment**

- 19.1 The supplier shall not assign, in whole or in part, its obligations to perform under the contract, except with the purchaser's prior written consent.

**20. Subcontracts**

- 20.1 The supplier shall notify the purchaser in writing of all subcontracts awarded under this contract if not already specified in the bid. Such notification, in the original bid or later, shall not relieve the supplier from any liability or obligation under the contract.

**21. Delays in the supplier's performance**

- 21.1 Delivery of the goods and performance of services shall be made by the supplier in accordance with the time schedule prescribed by the purchaser in the contract.
- 21.2 If at any time during performance of the contract, the supplier or its subcontractor(s) should encounter conditions impeding timely delivery of the goods and performance of services, the supplier shall promptly notify the purchaser in writing of the fact of the delay, its likely duration and its cause(s). As soon as practicable after receipt of the supplier's notice, the purchaser shall evaluate the situation and may at his discretion extend the supplier's time for performance, with or without the imposition of penalties, in which case the extension shall be ratified by the parties by amendment of contract.
- 21.3 The right is reserved to procure outside of the contract small quantities or to have minor essential services executed if an emergency arises, the supplier's point of supply is not situated at or near the place where the goods are required, or the supplier's services are not readily available.
- 21.4 Except as provided under GCC Clause 25, a delay by the supplier in the performance of its delivery obligations shall render the supplier liable to the imposition of penalties, pursuant to GCC Clause 22, unless an extension of time is agreed upon pursuant to GCC Clause 22.2 without the application of penalties.

Initial



21.5 Upon any delay beyond the delivery period in the case of a goods contract, the purchaser shall, without cancelling the contract, be entitled to purchase goods of a similar quality and up to the same quantity in substitution of the goods not supplied in conformity with the contract and to return any goods delivered later at the supplier's expense and risk, or to cancel the contract and buy such goods as may be required to complete the contract and without prejudice to his other rights, be entitled to claim damages from the supplier.

## 22. Penalties

22.1 Subject to GCC Clause 25, if the supplier fails to deliver any or all of the goods or to perform the services within the period(s) specified in the contract, the purchaser shall, without prejudice to its other remedies under the contract, deduct from the contract price, as a penalty, a sum calculated on the delivered price of the delayed goods or unperformed services using the current prime interest rate calculated for each day of the delay until actual delivery or performance. The purchaser may also consider termination of the contract pursuant to GCC Clause 23.

## 23. Termination for default

23.1 The purchaser, without prejudice to any other remedy for breach of contract, by written notice of default sent to the supplier, may terminate this contract in whole or in part:

- (a) If the supplier fails to deliver any or all of the goods within the period(s) specified in the contract, or within any extension thereof granted by the purchaser pursuant to GCC Clause 21.2;
- (b) If the supplier fails to perform any other obligation(s) under the contract; or
- (c) If the supplier, in the judgement of the purchaser, has engaged in corrupt or fraudulent practices in competing for or in executing the contract.

23.2 In the event the purchaser terminates the contract in whole or in part, the purchaser may procure, upon such terms and in such manner, as it deems appropriate, goods, works or services similar to those undelivered, and the supplier shall be liable to the purchaser for any excess costs for such similar goods, works or services. However, the supplier shall continue performance of the contract to the extent not terminated.

23.3 Where the purchaser terminates the contract in whole or in part, the purchaser may decide to impose a restriction penalty on the supplier by prohibiting such supplier from doing business with the public sector for a period not exceeding 10 years.

23.4 If a purchaser intends imposing a restriction on a supplier or any person associated with the supplier, the supplier will be allowed a time period of not more than fourteen (14) days to provide reasons why the envisaged restriction should not be imposed. Should the supplier fail to respond within the stipulated fourteen (14) days the purchaser may regard the supplier as having no objection and proceed with the restriction.

23.5 Any restriction imposed on any person by the purchaser will, at the discretion of the purchaser, also be applicable to any other enterprise or any partner, manager, director or other person who wholly or partly exercises or exercised or may exercise control over the enterprise of the first-mentioned person, and with which enterprise or person the first-mentioned person, is or was in the opinion of the purchaser actively associated.

23.6 If a restriction is imposed, the purchaser must, within five (5) working days of such imposition, furnish the National Treasury, with the following information:

- (i) The name and address of the supplier and / or person restricted by the purchaser;
- (ii) The date of commencement of the restriction
- (iii) The period of restriction; and
- (iv) The reasons for the restriction.

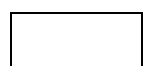

Initial

These details will be loaded in the National Treasury's central database of suppliers or persons prohibited from doing business with the public sector.

- 23.7. If a court of law convicts a person of an offence as contemplated in sections 12 or 13 of the Prevention and Combating of Corrupt Activities Act, No. 12 of 2004, the court may also rule that such person's name be endorsed on the Register for Tender Defaulters. When a person's name has been endorsed on the Register, the person will be prohibited from doing business with the public sector for a period not less than five years and not more than 10 years. The National Treasury is empowered to determine the period of restriction and each case will be dealt with on its own merits. According to section 32 of the Act the Register must be open to the public. The Register can be perused on the National Treasury website

#### **24. Antidumping and countervailing duties and rights**

- 24.1 When, after the date of bid, provisional payments are required, or anti-dumping or countervailing duties are imposed, or the amount of a provisional payment or anti-dumping or countervailing right is increased in respect of any dumped or subsidized import, the State is not liable for any amount so required or imposed, or for the amount of any such increase. When, after the said date, such a provisional payment is no longer required or any such anti-dumping or countervailing right is abolished, or where the amount of such provisional payment or any such right is reduced, any such favourable difference shall on demand be paid forthwith by the supplier to the purchaser or the purchaser may deduct such amounts from moneys (if any) which may otherwise be due to the supplier in regard to goods or services which he delivered or rendered, or is to deliver or render in terms of the contract or any other contract or any other amount which may be due to him.

#### **25. Force Majeure**

- 25.1 Notwithstanding the provisions of GCC Clauses 22 and 23, the supplier shall not be liable for forfeiture of its performance security, damages, or termination for default if and to the extent that his delay in performance or other failure to perform his obligations under the contract is the result of an event of force majeure.
- 25.2 If a force majeure situation arises, the supplier shall promptly notify the purchaser in writing of such condition and the cause thereof. Unless otherwise directed by the purchaser in writing, the supplier shall continue to perform its obligations under the contract as far as is reasonably practical, and shall seek all reasonable alternative means for performance not prevented by the force majeure event.

#### **26. Termination for insolvency**

- 26.1 The purchaser may at any time terminate the contract by giving written notice to the supplier if the supplier becomes bankrupt or otherwise insolvent. In this event, termination will be without compensation to the supplier, provided that such termination will not prejudice or affect any right of action or remedy, which has accrued or will accrue thereafter to the purchaser.

#### **27. Settlement of Disputes**

- 27.1 If any dispute or difference of any kind whatsoever arises between the purchaser and the supplier in connection with or arising out of the contract, the parties shall make every effort to resolve amicably such dispute or difference by mutual consultation.
- 27.2 If, after thirty (30) days, the parties have failed to resolve their dispute or difference by such mutual consultation, then either the purchaser or the supplier may give notice to the other party of his intention to commence with mediation. No mediation in respect of this matter may be commenced unless such notice is given to the other party.
- 27.3 Should it not be possible to settle a dispute by means of mediation, it may be settled in a South African court of law.
- 27.4 Notwithstanding any reference to mediation and/or court proceedings herein,

- (a) The parties shall continue to perform their respective obligations under the contract unless they otherwise agree;  
and

Initial

- (b) The purchaser shall pay the supplier any monies due the supplier for goods delivered and / or services rendered according to the prescripts of the contract.

**28. Limitation of Liability**

28.1 Except in cases of criminal negligence or wilful misconduct, and in the case of infringement pursuant to Clause 6;

- (a) The supplier shall not be liable to the purchaser, whether in contract, tort, or otherwise, for any indirect or consequential loss or damage, loss of use, loss of production, or loss of profits or interest costs, provided that this exclusion shall not apply to any obligation of the supplier to pay penalties and/or damages to the purchaser; and
- (b) The aggregate liability of the supplier to the purchaser, whether under the contract, in tort or otherwise, shall not exceed the total contract price, provided that this limitation shall not apply to the cost of repairing or replacing defective equipment.

**29. Governing language**

29.1 The contract shall be written in English. All correspondence and other documents pertaining to the contract that is exchanged by the parties shall also be written in English.

**30. Applicable law**

30.1 The contract shall be interpreted in accordance with South African laws, unless otherwise specified.

**31. Notices**

- 31.1 Every written acceptance of a bid shall be posted to the supplier concerned by registered or certified mail and any other notice to him shall be posted by ordinary mail to the address furnished in his bid or to the address notified later by him in writing and such posting shall be deemed to be proper service of such notice.
- 31.2 The time mentioned in the contract documents for performing any act after such aforesaid notice has been given, shall be reckoned from the date of posting of such notice.

**32. Taxes and duties**

- 32.1 A foreign supplier shall be entirely responsible for all taxes, stamp duties, license fees, and other such levies imposed outside the purchaser's country.
- 32.2 A local supplier shall be entirely responsible for all taxes, duties, license fees, etc., incurred until delivery of the contracted goods to the purchaser.
- 32.3 No contract shall be concluded with any bidder whose tax matters are not in order. Prior to the award of a bid SARS must have certified that the tax matters of the preferred bidder are in order.
- 32.4 No contract shall be concluded with any bidder whose municipal rates and taxes and municipal services charges are in arrears.

**33. Transfer of contracts**

33.1 The contractor shall not abandon, transfer, cede assign or sublet a contract or part thereof without the written permission of the purchaser

Initial

**34. Amendment of contracts**

34.1 No agreement to amend or vary a contract or order or the conditions, stipulations or provisions thereof shall be valid and of any force unless such agreement to amend or vary is entered into in writing and signed by the contracting parties. Any waiver of the requirement that the agreement to amend or vary shall be in writing, shall also be in writing.

**35. Prohibition of restrictive practices**

35.1 In terms of section 4 (1) (b) (iii) of the Competition Act No. 89 of 1998, as amended, an agreement between, or concerted practice by, firms, or a decision by an association of firms, is prohibited if it is between parties in a horizontal relationship and if a bidder(s) is / are or a contractor(s) was / were involved in collusive bidding.

35.2 If a bidder(s) or contractor(s) based on reasonable grounds or evidence obtained by the purchaser has / have engaged in the restrictive practice referred to above, the purchaser may refer the matter to the Competition Commission for investigation and possible imposition of administrative penalties as contemplated in section 59 of the Competition Act No 89 of 1998.

35.3 If a bidder(s) or contractor(s) has / have been found guilty by the Competition Commission of the restrictive practice referred to above, the purchaser may, in addition and without prejudice to any other remedy provided for, invalidate the bid(s) for such item(s) offered, and / or terminate the contract in whole or part, and / or restrict the bidder(s) or contractor(s) from conducting business with the public sector for a period not exceeding ten (10) years and / or claim damages from the bidder(s) or contractor(s) concerned.

Signed at ..... On this ..... day of ..... 20.....

**As Witnesses:**

1. ....

\_\_\_\_\_  
**BIDDER (SUPPLIER)**

2. ....

**\*NB:** This section to be completed by the ODM

Signed at ..... On this ..... day of ..... 20.....

**As Witnesses:**

1. ....

\_\_\_\_\_  
**CLIENT (ODM)**

2. ....

\_\_\_\_\_  
Initial

## APPLICATION OF PREFERENCE POINT SYSTEM IN TERMS OF THE PREFERENTIAL PROCUREMENT REGULATIONS 2017

The applicable **80/20** preferential points system as set out in Preferential Procurement Regulations 2017 will be used to evaluate individual quotations

**Regulation R.32 of 20 January 2017 provides for a preference points system**

***80/20 Preference point system [(for acquisition of goods or services for a Rand value equal to or above R30 000 and up to R50 million) (all applicable taxes included)]***

The points are awarded as follows:

- 80 points is awarded for the **lowest price** if it complies with the Quotations / Formal Written Price Quotation conditions.
- Additional points are awarded for attaining the **B-BBEE status level** of contributor in accordance with the table below:

B-BBEE Status Level of Contributor	Number of Points
1	20
2	18
3	14
4	12
5	8
6	6
7	4
8	2
Non-compliant contributor	0

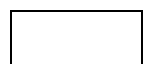

Initial

**SUPPLY AND DELIVERY OF GUARDRAIL BASEPLATES OR SUPPORTS**

**Q17-2020/21**

<p><b>SCHEDULE: PREFERENCE POINTS CLAIM FORM IN TERMS OF THE PREFERENTIAL PROCUREMENT REGULATIONS 2017</b></p>
--

This preference form must form part of all bids invited. It contains general information and serves as a claim form for preference points for Broad-Based Black Economic Empowerment (B-BBEE) Status Level of Contribution

**NB: BEFORE COMPLETING THIS FORM, BIDDERS MUST STUDY THE GENERAL CONDITIONS, DEFINITIONS AND DIRECTIVES APPLICABLE IN RESPECT OF B-BBEE, AS PRESCRIBED IN THE PREFERENTIAL PROCUREMENT REGULATIONS, 2017.**

**1. GENERAL CONDITIONS**

1.1 The following preference point systems are applicable to all bids:

- the 80/20 system for requirements with a Rand value of up to R50 000 000 (all applicable taxes included); and
- the 90/10 system for requirements with a Rand value above R50 000 000 (all applicable taxes included).

1.2 The value of this bid is estimated to not exceed R50 000 000 (all applicable taxes included) and therefore the 80/20 preference point system shall be applicable.

1.3 Points for this bid shall be awarded for:

- (a) Price; and
- (b) B-BBEE Status Level of Contributor.

1.4 The maximum points for this bid are allocated as follows:

	<b>POINTS</b>
<b>PRICE</b>	80
<b>B-BBEE STATUS LEVEL OF CONTRIBUTOR</b>	20
<b>Total points for Price and B-BBEE must not exceed</b>	<b>100</b>

1.5 Failure on the part of a bidder to submit proof of B-BBEE Status level of contributor together with the bid, will be interpreted to mean that preference points for B-BBEE status level of contribution are not claimed.

1.6 The purchaser reserves the right to require of a bidder, either before a bid is adjudicated or at any time subsequently, to substantiate any claim in regard to preferences, in any manner required by the purchaser.

--

Initial

## 2. DEFINITIONS

- (a) **“B-BBEE”** means broad-based black economic empowerment as defined in section 1 of the Broad-Based Black Economic Empowerment Act;
- (b) **“B-BBEE status level of contributor”** means the B-BBEE status of an entity in terms of a code of good practice on black economic empowerment, issued in terms of section 9(1) of the Broad-Based Black Economic Empowerment Act;
- (c) **“bid”** means a written offer in a prescribed or stipulated form in response to an invitation by an organ of state for the provision of goods or services, through price quotations, advertised competitive bidding processes or proposals;
- (d) **“Broad-Based Black Economic Empowerment Act”** means the Broad-Based Black Economic Empowerment Act, 2003 (Act No. 53 of 2003);
- (e) **“EME”** means an Exempted Micro Enterprise in terms of a code of good practice on black economic empowerment issued in terms of section 9 (1) of the Broad-Based Black Economic Empowerment Act;
- (f) **“Functionality”** means the ability of a bidder to provide goods or services in accordance with specifications as set out in the quotation documents.
- (g) **“prices”** includes all applicable taxes less all unconditional discounts;
- (h) **“proof of B-BBEE status level of contributor”** means:
  - 1) B-BBEE Status level certificate issued by an authorized body or person;
  - 2) A sworn affidavit as prescribed by the B-BBEE Codes of Good Practice;
  - 3) Any other requirement prescribed in terms of the B-BBEE Act;
- (i) **“QSE”** means a qualifying small business enterprise in terms of a code of good practice on black economic empowerment issued in terms of section 9 (1) of the Broad-Based Black Economic Empowerment Act;
- (j) **“rand value”** means the total estimated value of a contract in Rand, calculated at the time of bid invitation, and includes all applicable taxes;

## 3. POINTS AWARDED FOR PRICE

### 3.1 THE 80/20 PREFERENCE POINT SYSTEM

A maximum of 80 points is allocated for price on the following basis:

$$P_s = 80 \left( 1 - \frac{P_t - P_{\min}}{P_{\min}} \right)$$

Where

$P_s$  = Points scored for price of bid under consideration

$P_t$  = Price of bid under consideration

$P_{\min}$  = Price of lowest acceptable bid

**4. POINTS AWARDED FOR B-BBEE STATUS LEVEL OF CONTRIBUTOR**

4.1 In terms of Regulation 6 (2) and 7 (2) of the Preferential Procurement Regulations, preference points must be awarded to a bidder for attaining the B-BBEE status level of contribution in accordance with the table below:

<b>B-BBEE Status Level of Contributor</b>	<b>Number of points (80/20 system)</b>
1	20
2	18
3	14
4	12
5	8
6	6
7	4
8	2
Non-compliant contributor	0

**5. BID DECLARATION**

5.1 Bidders who claim points in respect of B-BBEE Status Level of Contribution must complete the following:

**6. B-BBEE STATUS LEVEL OF CONTRIBUTOR CLAIMED IN TERMS OF PARAGRAPHS 1.4 AND 4.1**

6.1 B-BBEE Status Level of Contributor:..... = .....(maximum of 20 points)  
 (Points claimed in respect of paragraph 7.1 must be in accordance with the table reflected in paragraph 4.1 and must be substantiated by relevant proof of B-BBEE status level of contributor.

**7. SUB-CONTRACTING**

7.1 Will any portion of the contract be sub-contracted?

*(Tick applicable box)*

YES	<input type="checkbox"/>	NO	<input type="checkbox"/>
-----	--------------------------	----	--------------------------

7.1.1 If yes, indicate:

- i) What percentage of the contract will be subcontracted.....%
- ii) The name of the sub-contractor.....
- iii) The B-BBEE status level of the sub-contractor.....
- iv) Whether the sub-contractor is an EME or QSE

*(Tick applicable box)*

YES	<input type="checkbox"/>	NO	<input type="checkbox"/>
-----	--------------------------	----	--------------------------

v) Specify, by ticking the appropriate box, if subcontracting with an enterprise in terms of Preferential Procurement Regulations,2017:

--

Initial



<b>Designated Group: An EME or QSE which is at last 51% owned by:</b>	<b>EME</b> √	<b>QSE</b> √
Black people		
Black people who are youth		
Black people who are women		
Black people with disabilities		
Black people living in rural or underdeveloped areas or townships		
Cooperative owned by black people		
Black people who are military veterans		
<b>OR</b>		
Any EME		
Any QSE		

**8. DECLARATION WITH REGARD TO COMPANY/FIRM**

8.1 Name of company/firm: .....

8.2 VAT registration number: .....

8.3 Company registration number: .....

**8.4 TYPE OF COMPANY/ FIRM**

- Partnership/Joint Venture / Consortium
  - One person business/sole propriety
  - Close corporation
  - Company
  - (Pty) Limited
- [TICK APPLICABLE BOX]

**8.5 DESCRIBE PRINCIPAL BUSINESS ACTIVITIES**

.....  
 .....  
 .....  
 .....

**8.6 COMPANY CLASSIFICATION**

- Manufacturer
  - Supplier
  - Professional service provider
  - Other service providers, e.g. transporter, etc.
- [TICK APPLICABLE BOX]

**8.7 MUNICIPAL INFORMATION**

**Municipality where business is situated:** .....

**Registered Account Number:** .....

**Stand Number:** .....

8.8 Total number of years the company/firm has been in business: .....

8.9 I/we, the undersigned, who is / are duly authorised to do so on behalf of the company/firm, certify that the points claimed, based on the B-BBE status level of contributor indicated in paragraphs 1.4 and 6.1 of the foregoing certificate, qualifies the company/ firm for the preference(s) shown and I / we acknowledge that:

- i) The information furnished is true and correct;
- ii) The preference points claimed are in accordance with the General Conditions as indicated in paragraph 1 of this form;
- iii) In the event of a contract being awarded as a result of points claimed as shown in paragraphs 1.4 and 6.1, the contractor may be required to furnish documentary proof to the satisfaction of the purchaser that the claims are correct;
- iv) If the B-BBEE status level of contributor has been claimed or obtained on a fraudulent basis or any of the conditions of contract have not been fulfilled, the purchaser may, in addition to any other remedy it may have –

- (a) disqualify the person from the bidding process;
- (b) recover costs, losses or damages it has incurred or suffered as a result of that person's conduct;
- (c) cancel the contract and claim any damages which it has suffered as a result of having to make less favourable arrangements due to such cancellation;
- (d) recommend that the bidder or contractor, its shareholders and directors, or only the shareholders and directors who acted on a fraudulent basis, be restricted by the National Treasury from obtaining business from any organ of state for a period not exceeding 10 years, after the *audi alteram partem* (hear the other side) rule has been applied; and
- (e) Forward the matter for criminal prosecution.

**Figure 1**

WITNESSES
1. ....
2. ....

.....
SIGNATURE(S) OF BIDDERS(S)
DATE: .....
ADDRESS .....
.....
.....

## BROAD-BASED BLACK ECONOMIC EMPOWERMENT (B-BBEE) STATUS LEVEL CERTIFICATES

A bidder who qualifies as an EME in terms of the B-BBEE Act **must** submit a sworn affidavit confirming Annual Total Revenue and Level of Black Ownership.

A Bidder other than EME or QSE **must submit their original and valid B-BBEE status level verification certificate or a certified copy** thereof, substantiating their B-BBEE rating issued by a Registered Auditor approved by IRBA or a Verification Agency accredited by SANAS.

MINIMUM REQUIREMENTS FOR VALID B-BBEE STATUS LEVEL VERIFICATION CERTIFICATES (The following information must be on the face of the certificate)	Indicate with (x)	
	yes	no
The name and the physical location of the measured entity		
The registration number and, where applicable, the VAT number of the measured entity		
The date of issue and date of expiry		
The certificate number for identification and reference		
The scorecard that was used (for example EME, QSE or Generic)		
The name and / or logo of the verification Agency		
The SANAS logo		
The certificate must be signed by the authorized person from the Verification Agency		
The B-BBEE Status level of Contribution obtained by the measured entity.		

Failure on the part of a bidder **to claim, fill in and/or to sign MBD 6.1 and submit a B-BBEE Verification Certificate from a Verification Agency accredited by the South African Accreditation System (SANAS), or a Registered Auditor approved by the Independent Regulatory Board of Auditors (IRBA) or a sworn affidavit confirming annual turnover and level of black ownership in case of an EME and QSE together with the bid, will be interpreted to mean that preference points for B-BBEE status level of contribution are not claimed.**

Signed ..... Date .....

Name ..... Position .....

Bidder .....

Initial

## FOR INFORMATION PURPOSES ONLY

**PLEASE NOTE THE FOLLOWING REQUIREMENTS REGARDING VALIDATION OF B-BBEE SCORE.**

### 1. EMEs

**ONLY THE FOLLOWING WILL BE ACCEPTED:**

- 1.1. **A VALID ORIGINAL** sworn affidavit, confirming annual turnover and level of black ownership or
- 1.2. **A VALID** affidavit / certificate issued by Companies Intellectual Property Commission (CIPC); or
- 1.3. **A VALID ORIGINAL** B-BBEE status level verification certificate or **A CERTIFIED COPY** thereof, substantiating their B-BBEE rating issued by:
  - 1.3.1. A registered Auditor approved by the Independent Regulatory Board for Auditors (IRBA); **or**
  - 1.3.2. A verification Agency accredited by the South African National Accreditation System (SANAS).

### 2. QSEs

**ONLY THE FOLLOWING WILL BE ACCEPTED:**

- 2.1. **A VALID ORIGINAL** sworn affidavit, confirming annual turnover and level of black ownership or
- 2.2. **A VALID ORIGINAL** B-BBEE status level verification certificate or **A CERTIFIED COPY** thereof, substantiating their B-BBEE rating issued by:
  - 2.2.1. A registered Auditor approved by IRBA; or
  - 2.2.2. A verification Agency accredited by SANAS.

### 3. BIDDERS OTHER THAN EMEs & QSE's

- 3.1. The bidder **MUST** submit either a **VALID ORIGINAL B-BBEE** status level verification certificate or **A CERTIFIED COPY** thereof, substantiating their **B-BBEE** rating issued by:
  - 3.1.1. A Registered Auditor approved by IRBA; or
  - 3.1.2. A Verification Agency accredited by SANAS.

### 3. **WHEN CONFIRMING THE VALIDITY OF CERTIFICATES ISSUED BY AN AUDITOR REGISTERED WITH IRBA, THE FOLLOWING SHOULD BE DETAILED ON THE FACE OF THE CERTIFICATE:**

- 4.1. The Auditor's letterhead with FULL contact details;
- 4.2. The Auditor's practice number;
- 4.3. The name and physical location of the measured entity;
- 4.4. The registration number and, where applicable, the VAT number of the measured entity;
- 4.5. The date of issue and date of expiry;
- 4.6. The B-BBEE Status Level of Contribution obtained by the measured entity; and
- 4.7. The total black shareholding and total black female shareholding.

Initial

**SWORN AFFIDAVIT – B-BBEE EXEMPTED MICRO ENTERPRISE**

I, the undersigned,

<b>Full name &amp; Surname</b>	
<b>Identity number</b>	

Hereby declare under oath as follows:

1. The contents of this statement are to the best of my knowledge a true reflection of the facts.
2. I am a member / director / owner of the following enterprise and am duly authorised to act on its behalf:

<b>Enterprise Name</b>	
<b>Trading Name</b>	
<b>Registration Number</b>	
<b>Enterprise Address</b>	

3. I hereby declare under oath that:

- The enterprise is \_\_\_\_\_% black owned;
- The enterprise is \_\_\_\_\_% black woman owned;
- Based on the management accounts and other information available on the \_\_\_\_\_ financial year, the income did not exceed R10, 000,000.00 (ten million rands);
- Please confirm on the table below the B-BBEE level contributor, by ticking the applicable box.

100% black owned	<b>Level One</b> (135% B-BBEE procurement recognition)	
More than 51% black owned	<b>Level Two</b> (125% B-BBEE procurement recognition)	
Less than 51% black owned	<b>Level Four</b> (100% B-BBEE procurement recognition)	

4. The entity is an empowering supplier in terms of **the dti** Codes of Good Practice.
5. I know and understand the contents of this affidavit and I have no objection to take the prescribed oath and consider the oath binding on my conscience and on the owners of the enterprise which I represent in this matter.
6. The sworn affidavit will be valid for a period of 12 months from the date signed by commissioner.

Deponent Signature: \_\_\_\_\_

Date: \_\_\_\_\_

\_\_\_\_\_  
Commissioner of Oaths  
Signature & stamp

Initial

--

## CONTRACT FORM – PURCHASE OF GOODS/WORKS

**THIS FORM MUST BE FILLED IN DUPLICATE BY BOTH THE SUCCESSFUL BIDDER (PART 1) AND THE PURCHASER (PART 2). BOTH FORMS MUST BE SIGNED IN THE ORIGINAL SO THAT THE SUCCESSFUL BIDDER AND THE PURCHASER WOULD BE IN POSSESSION OF ORIGINALLY SIGNED CONTRACTS FOR THEIR RESPECTIVE RECORDS.**

### PART 1 (TO BE FILLED IN BY THE BIDDER)

1. I hereby undertake to supply all or any of the goods and/or works described in the attached bidding documents to **Overberg District Municipality** in accordance with the requirements and specifications stipulated in bid number **Q17-2020/21** at the price/s quoted. My offer/s remains binding upon me and open for acceptance by the purchaser during the validity period indicated and calculated from the closing time of bid.
  
2. The following documents shall be deemed to form and be read and construed as part of this agreement:
  - (i) Bidding documents, viz
    - Invitation to bid;
    - Tax Compliance Status Pin Issued;
    - Pricing schedule(s);
    - Technical Specification(s);
    - Preference claims for Broad Based Black Economic Empowerment Status Level of Contribution in terms of the Preferential Procurement Regulations 2017;
    - Declaration of interest;
    - Declaration of bidder's past SCM practices;
    - Certificate of Independent Bid Determination
    - Special Conditions of Contract;
  - (ii) General Conditions of Contract; and
  - (iii) Other (specify)
  
3. I confirm that I have satisfied myself as to the correctness and validity of my bid; that the price(s) and rate(s) quoted cover all the goods and/or works specified in the bidding documents; that the price(s) and rate(s) cover all my obligations and I accept that any mistakes regarding price(s) and rate(s) and calculations will be at my own risk.
  
4. I accept full responsibility for the proper execution and fulfilment of all obligations and conditions devolving on me under this agreement as the principal liable for the due fulfilment of this contract.
  
5. I declare that I have no participation in any collusive practices with any bidder or any other person regarding this or any other bid.
  
6. I confirm that I am duly authorised to sign this contract.

NAME (PRINT) .....

CAPACITY .....

SIGNATURE .....

NAME OF FIRM .....

DATE .....

WITNESSES	
1	.....
2.	.....

Initial

\*NB: This form to be completed by the ODM

MBD 7.1

**CONTRACT FORM – PURCHASE OF GOODS/WORKS**

**PART 2 (TO BE FILLED IN BY THE PURCHASER)**

I..... in my capacity  
as .....

- I. Accept your bid under reference number **Q17-2020/21** dated ..... for the supply of goods/works indicated hereunder and/or further specified in the annexure(s).
- II. An official order indicating delivery instructions is forthcoming.
- III. I undertake to make payment for the goods/works delivered in accordance with the terms and conditions of the contract, within 30 (thirty) days after receipt of an invoice accompanied by the delivery note.

<b>ITEM NO.</b>	<b>PRICE (ALL APPLICABLE TAXES INCLUDED)</b>	<b>BRAND</b>	<b>DELIVERY PERIOD</b>	<b>B-BBEE STATUS LEVEL OF CONTRIBUTION</b>	<b>MINIMUM THRESHOLD FOR LOCAL PRODUCTION AND CONTENT (if applicable)</b>

a. I confirm that I am duly authorized to sign this contract.

SIGNED AT .....ON.....

NAME (PRINT) .....

SIGNATURE .....

OFFICIAL STAMP

WITNESSES

- 1. ....
- 2. ....

Initial

## DECLARATION OF BIDDER'S PAST SUPPLY CHAIN MANAGEMENT PRACTICES

- 1 This Standard Bidding Document must form part of all bids invited.
- 2 It serves as a declaration to be used by institutions in ensuring that when goods and services are being procured, all reasonable steps are taken to combat the abuse of the supply chain management system.
- 3 The bid of any bidder may be disregarded if that bidder or any of its directors have-
  - a. abused the institution's supply chain management system;
  - b. committed fraud or any other improper conduct in relation to such system; or
  - c. failed to perform on any previous contract.
- 4 **In order to give effect to the above, the following questionnaire must be completed and submitted with the bid.**

4.1	Is the bidder or any of its directors listed on the National Treasury's database as a company or person prohibited from doing business with the public sector? <b>(Companies or persons who are listed on this database were informed in writing of this restriction by the National Treasury after the <i>audi alteram partem</i> rule was applied).</b>	Yes	No
4.1.1	If so, furnish particulars:		
4.2	Is the bidder or any of its directors listed on the Register for Tender Defaulters in terms of section 29 of the Prevention and Combating of Corrupt Activities Act (No 12 of 2004)? <b>(To access this Register enter the National Treasury's website, <a href="http://www.treasury.gov.za">www.treasury.gov.za</a>, click on the icon "Register for Tender Defaulters" or submit your written request for a hard copy of the Register to facsimile number (012) 3265445.)</b>	Yes	No
4.2.1	If so, furnish particulars:		
4.3	Was the bidder or any of its directors convicted by a court of law (including a court outside of the Republic of South Africa) for fraud or corruption during the past five years?	Yes	No
4.3.1	If so, furnish particulars:		
4.4	Was any contract between the bidder and the municipality / municipal entity or any other organ of state terminated during the past five years on account of failure to perform on or comply with the contract?	Yes	No
4.4.1	If so, furnish particulars:		
4.5	Does the bidder or any of its directors owe any municipal rates and taxes or municipal charges to the municipality / municipal entity, or to any other municipality / municipal entity, that is in arrears for more than three months?	Yes	No
4.5.1	If so, furnish particulars		

Initial



**CERTIFICATION**

I, THE UNDERSIGNED (FULL NAME) .....

**CERTIFY THAT THE INFORMATION FURNISHED ON THIS DECLARATION FORM TRUE AND CORRECT.**

**I ACCEPT THAT, IN ADDITION TO CANCELLATION OF A CONTRACT, ACTION MAY BE TAKEN AGAINST ME SHOULD THIS DECLARATION PROVE TO BE FALSE.**

.....

**Signature**

.....

**Date**

.....

**Position**

.....

**Name of Bidder**

**Initial**

--

**NOTIFICATION OF DECISION**

1. If the Supply Chain Management Bid Adjudication Committee, or the Municipal Manager, has resolved that a bid be accepted, the successful and unsuccessful bidders shall be notified in writing of this decision.
2. Regulation 50 of the Supply Chain Management Regulations gives any person whose rights have been affected by such a decision, the right to lodge an objection, complaint or dispute to query such decision within **14 days** of notification of the decision.
3. Any bidder wishing to exercise this right must submit their objection, complaint, dispute or query in writing to the Municipal Manager, Private bag X22, Bredasdorp, 7280. The format of the objection, complain, dispute or query must-
  - set out the reasons for objection, complaint, dispute or query;
  - state in which way the bidders rights have been affected by the decision;
  - state the remedy sought, and
  - be accompanied by a copy of the notification advising the bidder of the decision of the Supply Chain Management Bid Adjudication Committee or Municipal Manager as applicable.
4. Bidders are also hereby informed of their right to request reasons for the decision in terms of the Promotion of Administrative Justice Act (No 3 of 2000).
5. The notification of decision sent to the successful bidder is not acceptance in terms of the form of offer and acceptance and no rights shall accrue to the successful bidder in terms of this notification.

**Initial**

--

**CERTIFICATE OF INDEPENDENT BID DETERMINATION**

- 1 This Municipal Bidding Document (MBD) must form part of all bids<sup>1</sup> invited.
- 2 Section 4 (1) (b) (iii) of the Competition Act No. 89 of 1998, as amended, prohibits an agreement between, or concerted practice by, firms, or a decision by an association of firms, if it is between parties in a horizontal relationship and if it involves collusive bidding (or bid rigging)<sup>2</sup>. Collusive bidding is a *pe se* prohibition meaning that it cannot be justified under any grounds.
- 3 Municipal Supply Regulation 38 (1) prescribes that a supply chain management policy must provide measures for the combating of abuse of the supply chain management system, and must enable the accounting officer, among others, to:
  - a. take all reasonable steps to prevent such abuse;
  - b. reject the bid of any bidder if that bidder or any of its directors has abused the supply chain management system of the municipality or municipal entity or has committed any improper conduct in relation to such system; and
  - c. cancel a contract awarded to a person if the person committed any corrupt or fraudulent act during the bidding process or the execution of the contract.
- 4 This MBD serves as a certificate of declaration that would be used by institutions to ensure that, when bids are considered, reasonable steps are taken to prevent any form of bid-rigging.
- 5 In order to give effect to the above, the attached Certificate of Bid Determination (MBD 9) must be completed and submitted with the bid:

<sup>1</sup> Includes price quotations, advertised competitive bids, limited bids and proposals.

<sup>2</sup> Bid rigging (or collusive bidding) occurs when businesses, that would otherwise be expected to compete, secretly conspire to raise prices or lower the quality of goods and / or services for purchasers who wish to acquire goods and / or services through a bidding process. Bid rigging is, therefore, an agreement between competitors not to compete.

Initial

**CERTIFICATE OF INDEPENDENT BID DETERMINATION**

I, the undersigned, in submitting the accompanying bid:

**BID NO: Q17-2020/21 SUPPLY AND DELIVERY OF GUARDRAIL BASEPLATES OR SUPPORTS**

In response to the invitation for the bid made by:

**OVERBERG DISTRICT MUNICIPALITY**

Do hereby make the following statements that I certify to be true and complete in every respect:

I certify, on behalf of: \_\_\_\_\_ that:  
(Name of Bidder)

1. I have read, and I understand the contents of this Certificate;
2. I understand that the accompanying bid will be disqualified if this Certificate is found not to be true and complete in every respect;
3. I am authorized by the bidder to sign this Certificate, and to submit the accompanying bid, on behalf of the bidder;
4. Each person whose signature appears on the accompanying bid has been authorized by the bidder to determine the terms of, and to sign, the bid, on behalf of the bidder;
5. For the purposes of this Certificate and the accompanying bid, I understand that the word "competitor" shall include any individual or organization, other than the bidder, whether or not affiliated with the bidder, who:
  - (a) Has been requested to submit a bid in response to this bid invitation;
  - (b) Could potentially submit a bid in response to this bid invitation, based on their qualifications, abilities or experience; and
  - (c) Provides the same goods and services as the bidder and/or is in the same line of business as the bidder, who:
6. The bidder has arrived at the accompanying bid independently from, and without consultation, communication, agreement or arrangement with any competitor. However, communication between partners in a joint venture or consortium<sup>3</sup> will not be construed as collusive bidding.

<sup>3</sup> Joint venture or Consortium means an association of persons for the purpose of combining their expertise, property, capital, efforts, skill and knowledge in an activity for the execution of a contract.

Initial

7. In particular, without limiting the generality of paragraphs 6 above, there has been no consultation, communication, agreement or arrangement with any competitor regarding:
  - (a) Prices;
  - (b) Geographical area where product or service will be rendered (market allocation)
  - (c) Methods, factors or formulas used to calculate prices;
  - (d) The intention or decision to submit or not to submit, a bid;
  - (e) The submission of a bid which does not meet the specifications and conditions of the bid; or
  - (f) Bidding with the intention not to win the bid.
  
8. In addition, there have been no consultations, communications, agreements or arrangements with any competitor regarding the quality, quantity, specifications and conditions or delivery particulars of the products or services to which this bid invitation relates.
  
9. The terms of the accompanying bid have not been, and will not be, disclosed by the bidder, directly or indirectly, to any competitor, prior to the date and time of the official bid opening or of the awarding of the contract.
  
10. I am aware that, in addition and without prejudice to any other remedy provided to combat any restrictive practices related to bids and contracts, bids that are suspicious will be reported to the Competition Commission for investigation and possible imposition of administrative penalties in terms of section 59 of the Competition Act No. 89 of 1998 and or may be reported to the National Prosecuting Authority (NPA) for criminal investigation and or may be restricted from conducting business with the public sector for a period not exceeding ten (10) years in terms of the Prevention and Combating of Corrupt Activities Act No. 12 of 2004 or any other applicable legislation.

SIGNATURE		NAME (PRINT)	
CAPCITY		DATE	
NAME OF FIRM			

Initial

--

### KEY PERFORMANCE INDICATORS

No	Key Performance Indicators (KPIs)
1	Project management and control
2	Communications
3	Flexibility
4	Capability
5	Delivery

I / We acknowledge that I / we am / are fully acquainted with the abovementioned Key Performance Indicators (KPIs) applicable to this tender / contract as stipulated by the Municipality and that I / we accept these Key Performance Indicators (KPIs) in all respects.

I / We furthermore confirm I / we satisfied myself / ourselves as to the corrections and validity of my / our tender: that the price quoted cover all the work / item(s) specified in the tender document and that the price cover all my / our obligations under a resulting contract and that I / we accept that any mistake(s) regarding price and calculations will be at my / our risk.

SIGNATURE		NAME (PRINT)	
CAPCITY		DATE	
NAME OF FIRM			
WITNESS 1		WITNESS 2	

Initial

--

**ANNEXURE A**



**BID NO: Q17-2020/21 SUPPLY AND DELIVERY OF GUARDRAIL BASEPLATES OR SUPPORTS**

**Authorization to deduct outstanding amounts**

**To: Municipal Manager, Overberg District Municipality**

**From:** \_\_\_\_\_  
**(Name of Bidder or Consortium)**

**AUTHORISATION FOR THE DEDUCTION OF OUTSTANDING AMOUNTS OWED TO COUNCIL**

**I, THE UNDERSIGNED,** \_\_\_\_\_,  
**(Full name in block letters)**

*Hereby authorize the Overberg District Municipality to deduct the full amount outstanding by the business organization / Director, shareholder, partner, etc. from any payment due to us / me.*

.....  
Signature

**THUS, DONE AND SIGNED** for and on behalf of the Bidder / Contractor

At ..... On the ..... day of ..... 20.....  
(Place) (Date) (Month) (Year)

In the presence of the subscribing witnesses.

AS WITNESSES:

1..... Name in Block Letters: .....  
(Signature)

2..... Name in Block Letters: .....  
(Signature)

**Initial**

### PAYMENT OF MUNICIPAL ACCOUNTS

In terms of the Municipal Supply Chain Management Policy and System and its Preferential Procurement Policy, bidders **must** ensure that they are up-to date with their payments of municipal accounts. The bidder **must attach to this page**, a Latest Municipal account, which provides proof that his payment of Municipal accounts is up-to-date and complete the certificate for municipal services on the next page. In the event of leasing, a lease agreement **Must** be attached to the quotation document.

Signed .....

Date .....

Name .....

Position .....

Bidder .....

Initial



## ANNEXURE B

### CERTIFICATE FOR MUNICIPAL SERVICES (COMPULSORY TO COMPLETE)

**DECLARATION IN TERMS OF CLAUSE 112(1) OF THE MUNICIPAL FINANCE MANAGEMENT ACT (NO.56 OF 2003) - (To be signed in the presence of a Commissioner of Oaths)**

I, \_\_\_\_\_, \_\_\_\_\_ (full name and ID no.), hereby acknowledge that according to SCM Regulation 38(1)(d)(i), the Municipality may reject the quotation of the bidder if any municipal rates and taxes or municipal service charges owed by the Bidder or any of its directors/members/partners to the Overberg District Municipality, or to any other municipality or municipal entity, are in arrears for more than 3 (three) months.

I declare that I am duly authorised to act on behalf of \_\_\_\_\_ (name of the firm) and hereby declare, that to the best of my personal knowledge, neither the firm nor any director/member/partner of said firm is in arrears on any of its municipal accounts with any municipality in the Republic of South Africa, for a period longer than 3 (three) months.

I further hereby certify that the information set out in this schedule and/or attachment(s) hereto is true and correct. The bidder acknowledges that failure to complete this schedule properly and truthfully may result in the quotation being disqualified, and/or in the event that the bidder is successful, the cancellation of the contract.

PHYSICAL BUSINESS ADDRESS(ES) OF THE BIDDER	MUNICIPAL ACCOUNT NUMBER

**FURTHER DETAILS OF THE BIDDER'S Director / Shareholder Partners, ect.:**

Director /Shareholder / partner	Physical address of the Business	Municipal Account number(s)	Physical residential address of the Director / shareholder / partner	Municipal Account number(s)

**NB: Please attach certified copy(ies) of ID document(s)**

**If the entity or any of its Directors/Shareholders/Partners, etc. rents/leases premises, a copy of the rental/lease agreement must be submitted with this quotation.**

**Number of sheets appended by the bidder to this schedule (If nil, enter NIL)**

--	--

<b>Signature</b>	<b>Position</b>	<b>Date</b>

<p style="text-align: center;"><b>COMMISSIONER OF OATHS</b></p> <p>Signed and sworn to before me at _____, on this _____ day of _____ 20____</p> <p>by the Deponent, who has acknowledged that he/she knows and understands the contents of this Affidavit, it is true and correct to the best of his/her knowledge and that he/she has no objection to taking the prescribed oath, and that the prescribed oath will be binding on his/her conscience.</p> <p><b>COMMISSIONER OF OATHS:-</b></p> <p>Position: _____</p> <p>Address _____</p> <p>Tel: _____</p>	<p><b>Apply official stamp of authority on this page:</b></p>
---	---

Initial

--



**COMPULSORY TO COMPLETE**

**CHECK LIST FOR COMPLETENESS OF BID DOCUMENT**

The bidder must ensure that the following checklist is completed, that the necessary documentation is attached to this bid document and that all declarations are signed:

*\*Mark with "X" where applicable*

Items to be checked	Yes	No	Comments
1. Completed page containing the details of bidder			
2. Valid Tax Compliance Status Pin Issued attached to bid document (MBD 2). <b>a. Bidders who are registered on the municipality's accredited supplier database and attached a valid Tax Compliance Status Pin Issued to their database application form does not need to submit a Tax Compliance Status Pin Issued with their bid document.</b>			
3. Adhered to the pricing instructions (MBD 3.1)			
4. Schedule of previous experience of bidder on page 4 must be completed			
5. Completed and signed declaration of interest (MBD 4)			
6. Signed declaration of bidder's past supply chain management practices (MBD 8)			
7. Certificate of independent bid determination (MBD 9) be completed and signed			
8. Attach a recent Municipal Account of the Company <b>AND</b> of each Director/Member/Partner			
9. Bidder must initial every page of this bid document			

**CERTIFICATION**

I, THE UNDERSIGNED (FULL NAME) .....

**CERTIFY THAT THE INFORMATION FURNISHED ON THIS CHECK LIST IS TRUE AND CORRECT.**

.....  
**Signature**

.....  
**Date**

.....  
**Position**

.....  
**Name**

**Initial**

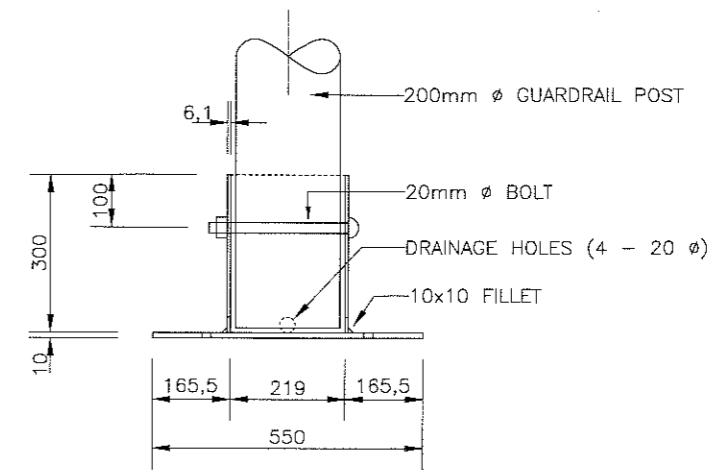
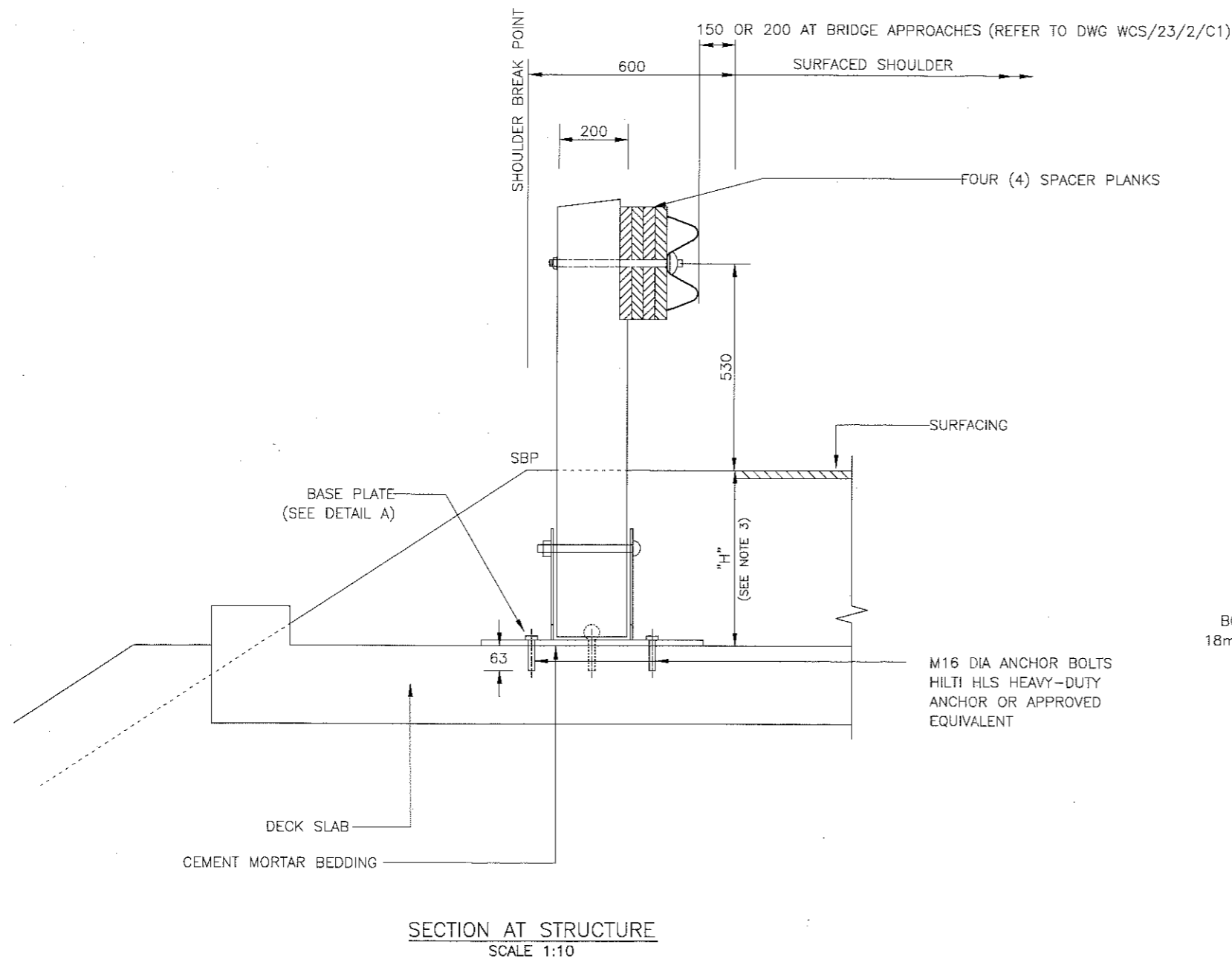

SECTION X-X

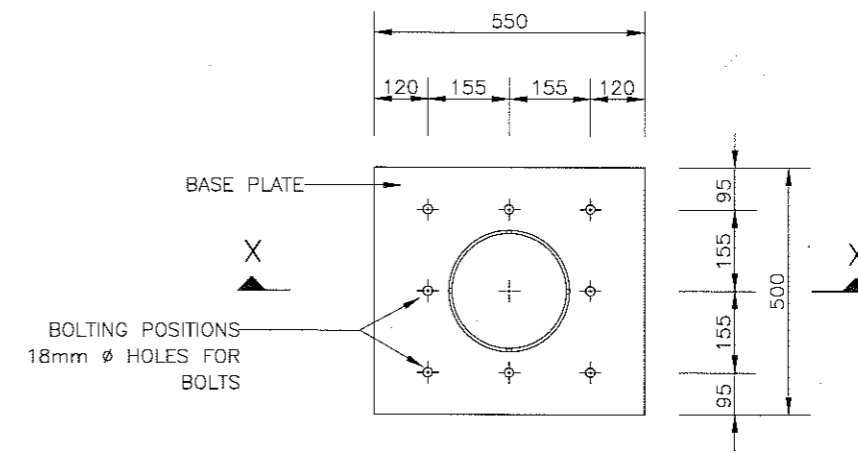

DETAIL A  
SCALE 1:10

NOTES :

1. ALL STEEL AND WELDING TO COMPLY WITH SECTION 6700 OF COLTO STANDARD SPECIFICATION.
2. POST AND BASE FRAME SHALL BE HOT-DIP GALVANIZED WITH A 85 MICRON COATING IN ACCORDANCE WITH SANS 121.
3. THIS DETAIL IS APPLICABLE WHERE "H" < 1,0m.

No.	DATE	ADDITIONS AND AMENDMENTS	APPROVED	DATE	Issue Date:	STANDARD PLANS	L.G.FOURIE CHIEF DIRECTOR ROAD NETWORK MANAGEMENT	GUARDRAILS	SCALE : N.T.S.	INDEX NO. WCS/54/1/C4
					2019	WESTERN CAPE GOVERNMENT DEPARTMENT OF TRANSPORT AND PUBLIC WORKS		GUARDRAIL ON CULVERTS	A2 ORIGINAL	PLAN NO. SHEET 4 OF 7